

DOOR AND JAMB DETAIL

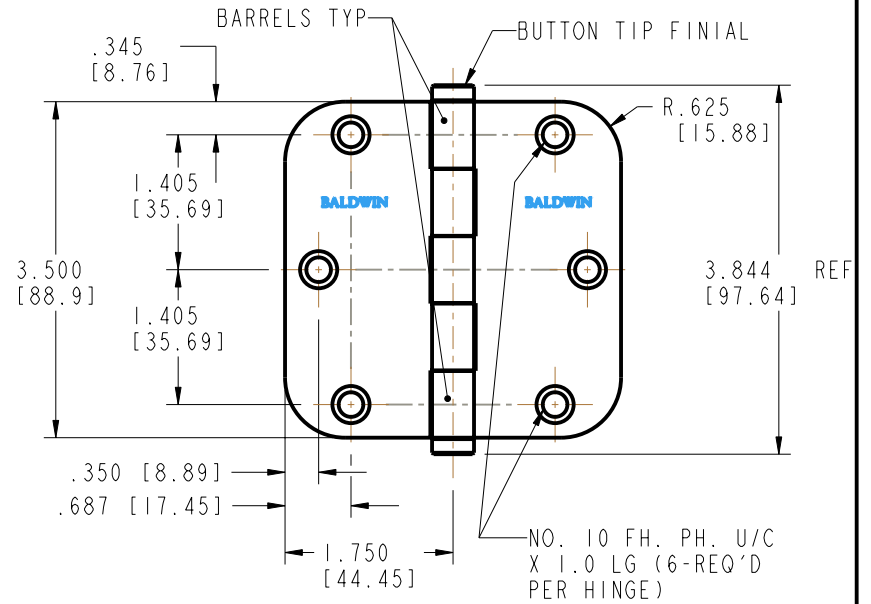

- NOTES:
1. AVAILABLE WITH ANY OF THE DECORATIVE FINIALS SHOWN.
 2. ALL FINIALS ARE INTERCHANGEABLE AND THREAD INTO THE TOP AND BOTTOM OF THE HINGE BARRELS.
 3. STAINLESS STEEL HINGE PINS ARE REMOVABLE TO FACILITATE INSTALLATION.

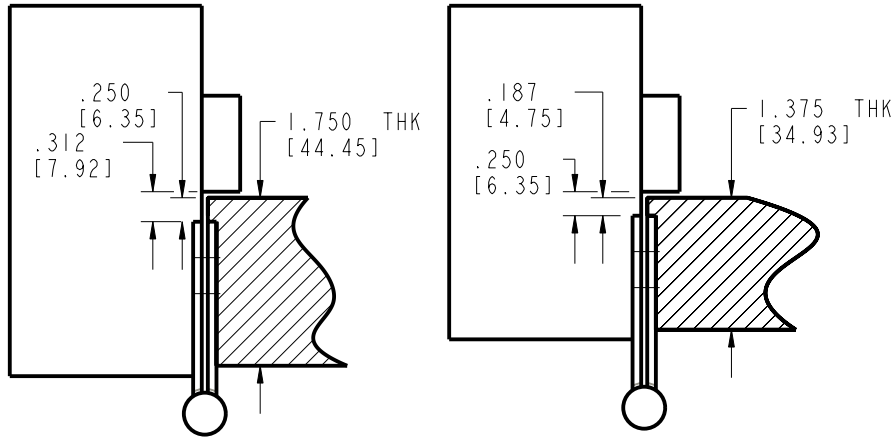
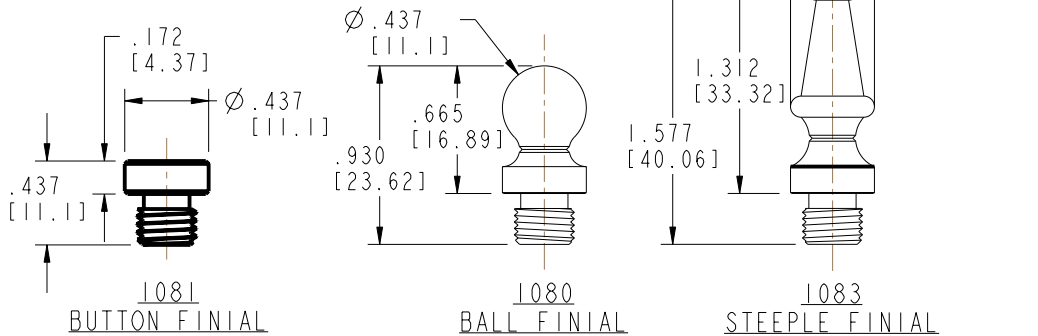
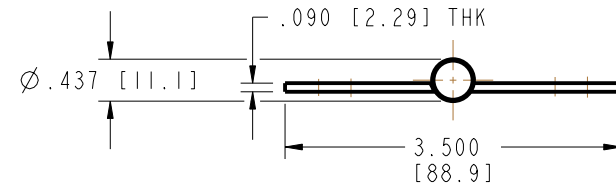

EFFECTIVE -



BALDWIN
HARDWARE CORPORATION
READING, PENNSYLVANIA

1135 MORTISE HINGE

TEMPLATE: NO VARIATIONS

TEMPLATE NO.

DO NOT SCALE DRAWING

©2002 BY BALDWIN HARDWARE CORPORATION

B135