

# RIM LOCKS – STANDARDS & SPECIFICATIONS

Pride in our American Heritage and renewed interest in its early history has greatly influenced U.S. architecture. With careful research and design, Baldwin has authentically reproduced a piece of that heritage – colonial rim locks.

- > Constructed with solid forged brass parts for exceptional durability and smooth operation
- > Trim designs secured to a broached spindle with an epoxy (resin) coated set screw – prohibits screw from loosening
- > Interior rim locks use bit keys. Bit keys may be ordered fixed permanently into the lock by ordering as .RBIT or .LBIT configurations.

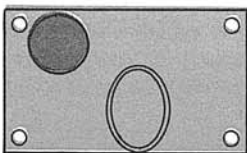
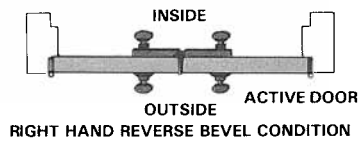
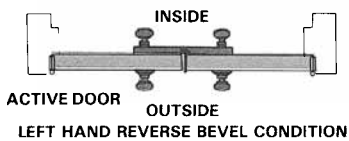
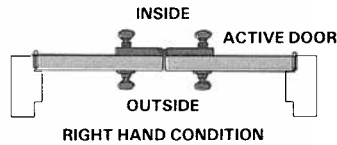
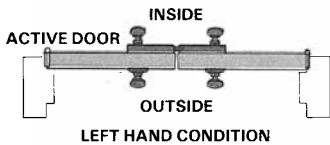
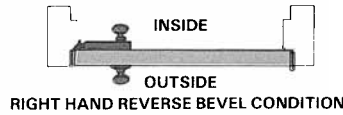
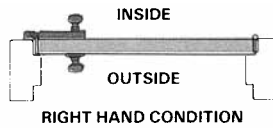
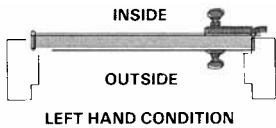
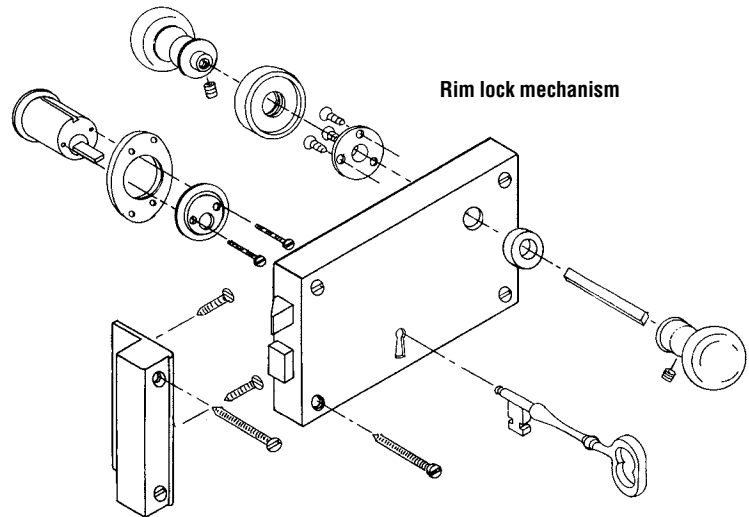

Handing of Rim Lock Plates

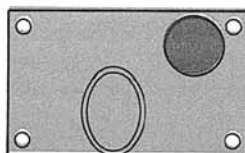

NOTE: Hand of door is always determined from outside  
IMPORTANT: A dummy trim rim lock must be used on ALL pairs of reverse bevel doors

LEFT HAND CONDITION  
(SINGLE DOOR)

RIGHT HAND CONDITION  
(SINGLE DOOR)