

1-Year Limited Warranty

The Coleman Company, Inc. ("Coleman") warrants that for a period of one (1) year from the date of purchase, this product will be free from defects in materials and workmanship. Coleman, at its option, will repair or replace this product or any component of the product found to be defective during the warranty period. Replacement will be made with a new or remanufactured product or component. If the product is no longer available, replacement may be made with a similar product of equal or great value. This is your exclusive warranty.

This warranty is valid for the original retail purchaser from the date of initial retail purchase and is not transferable. Keep the original sales receipt. Proof of purchase is required to obtain warranty performance. Coleman dealers, service center, or retail stores selling Coleman products do not have the right to alter, modify or in any way change the terms and conditions of this warranty.

This warranty does not cover normal wear of parts or damage resulting from any of the following: negligent use or misuse of the product; use contrary to the operating instructions; commercial, for-profit, non-profit, instructional or educational use of this product; and repair or alteration by anyone other than Coleman or an authorized service center. Further, the warranty does not cover Acts of God, such as fire, flood, hurricanes and tornadoes.

COLEMAN SHALL NOT BE LIABLE FOR ANY INCIDENTAL OR CONSEQUENTIAL DAMAGES CAUSED BY BREACH OF ANY EXPRESS OR IMPLIED WARRANTY, BREACH OF CONTRACT OR OTHERWISE. EXCEPT TO THE EXTENT PROHIBITED BY APPLICABLE LAW, ANY IMPLIED WARRANTY OF MERCHANTABILITY OR FITNESS FOR A PARTICULAR PURPOSE IS LIMITED IN DURATION TO THE DURATION OF THE ABOVE WARRANTY. SOME STATES OR JURISDICTIONS DO NOT ALLOW THE EXCLUSION OR LIMITATION OF INCIDENTAL OR CONSEQUENTIAL DAMAGES OR LIMITATIONS ON HOW LONG AN IMPLIED WARRANTY LASTS, SO THE ABOVE LIMITATIONS OR EXCLUSIONS MAY NOT APPLY TO YOU. THIS WARRANTY GIVES YOU SPECIFIC LEGAL RIGHTS, AND YOU MAY ALSO HAVE OTHER RIGHTS THAT VARY FROM STATE TO STATE.

How to Obtain Warranty Service

Take the product to an authorized Coleman service center. You can find the nearest authorized Coleman service center by calling 1-800-835-3278 or TDD 316-832-8707. If a service center is not conveniently located, attach a tag to the product that includes your name, address, daytime telephone number and description of the problem. Include a copy of the original sales receipt. Carefully package the product and send either by courier or mail to:

The Coleman Company, Inc.
3600 North Hydraulic
Wichita, KS 67219

This warranty does not include transportation or shipping costs. If you ship your product, shipping and insurance must be prepaid.

DO NOT RETURN THIS PRODUCT TO THE PLACE OF PURCHASE.

If you have any questions regarding this warranty, please call 1-800-835-3278 or TDD 316-832-8707.



The Coleman Company, Inc.
3600 N. Hydraulic • Wichita, Kansas 67219
1-800-835-3278 • www.coleman.com

MADE IN CHINA • PRINTED IN CHINA

Patents Pending

© 2005 The Coleman Company, Inc.

Coleman®, , and BackHome® are registered trademarks of The Coleman Company, Inc.



B a c k H o m e™

Willow Collection BackHome® Shelter 10' x 10'

Set-up Instructions
Part Number 9391-652

Before you begin:

Read all instructions before set up.

- Select a clear and level surface to install your shelter.

⚠ WARNING: Keep clear of overhead power lines.

- Determine type of stake or fastener needed for your installation (wood, concrete, etc.).
- It is important to the stability and life of your shelter to have a secure mounting surface.
- Consult a local contractor for any local building code requirements.
- Enlist the help of at least 2 people to assist you when it is time to lift the canopy assembly.

Tools required:

- Flat or Phillips head screwdriver
- Adjustable wrench or 19 mm and 14 mm wrench
- Small ladder or step stool

Hardware Box Contents:

Letter ID	Description	Part #
a)	1 Canopy Hub	9391-2021
b)	1 Finial	9391-2031
c)	1 Large Bolt without Nut	9391-2041
d)	1 Vent Hub	9391-2051
e)	4 Corner Brackets w/Screw	9391-2061
f)	4 Acorn Nuts	9391-2071
g)	4 Sidewall Brackets	9391-2081
h)	4 Sidewall Tie Plates	9391-2091
i)	12 Short - 1" Screws (1/4" diameter) w/Nuts	9391-2101
j)	32 long - 1 1/2" Screws (1/4" diameter) w/Nuts	9391-2111
k)	8 - 1/2" Screws	9391-2121

Frame Materials:

l)	4 Decorative Side Panels w/T-Bar Edge	9391-2131
m)	4 Decorative Side Panels-Flat	9391-2141
n)	8 - 58 3/4" Eave Poles w/screw holes	9391-2151
o)	4 - 82 3/8" Corner Canopy Poles (long)w/screw holes & spring clips	9391-2161
p)	4 - 60" Sidewall Canopy Poles (short) w/spring clips	9391-2171
q)	4 Vent Poles	9391-2181

Canopies:

r)	1 Vent Cover	9391-2011
s)	1 Canopy	9391-2001

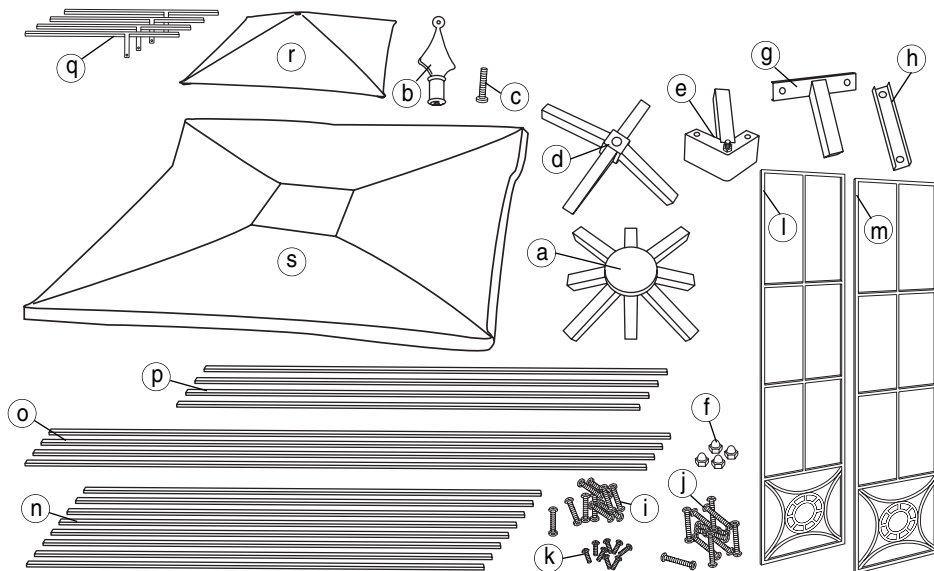

Attach Canopy Assembly to Side Panel Assemblies:

(continued)

6. Wrap all velcro straps on canopy around canopy frame and secure. (Fig. 16)

Important: To prevent water from pooling on the canopy, adjust fabric tension by tightening velcro straps. Test with water hose to make sure pooling does not occur.

You are now ready to enjoy your Coleman® BackHome® Shelter.

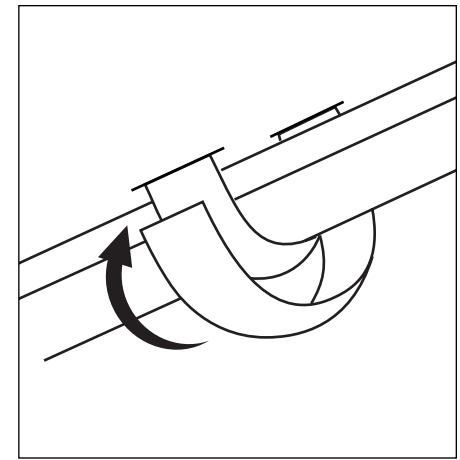

Fig. 16

Things You Should Know:

- TO EXTEND THE LIFE OF YOUR SHELTER, REMOVE AND STORE CANOPY DURING PERIODS OF POTENTIAL SNOW AND ICE.
- Never store shelter, even for a short period of time, without drying it thoroughly and brushing off caked dirt. Do not pack stakes or poles inside your shelter.

If using stakes:

- Stakes should be removed by pulling on the stake itself. Never pull on the shelter to remove stake.

⚠ WARNING: Keep all flame and heat sources away from this shelter fabric.

This shelter meets the flammability requirements of CPAI-84. The fabric will burn if left in continuous contact with any flame source. The application of any foreign substance to the shelter fabric may render the flame-resistant properties ineffective.

Attach Canopy Assembly to Side Panel Assemblies: (continued)

- Lift the canopy (requires 2 people). Have a helper place corner supports under corners of roof structure. (Fig. 13)

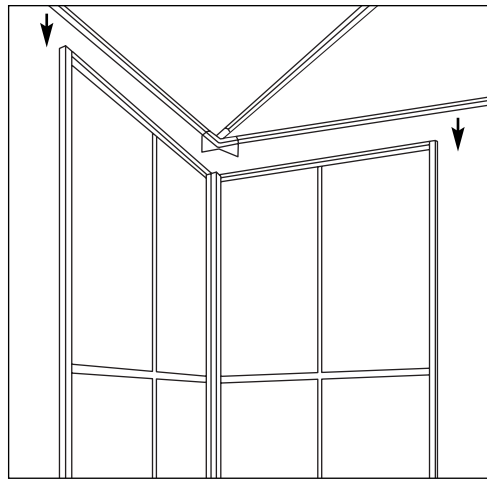

Fig. 13

- Starting in one corner, align holes in side panel with holes in canopy frame. From the top, insert four (4) 1 1/2" screws (j) through the holes and secure with nuts (Fig. 14). Repeat this step at remaining 3 corners.

NOTE: Tighten all screw at this time.

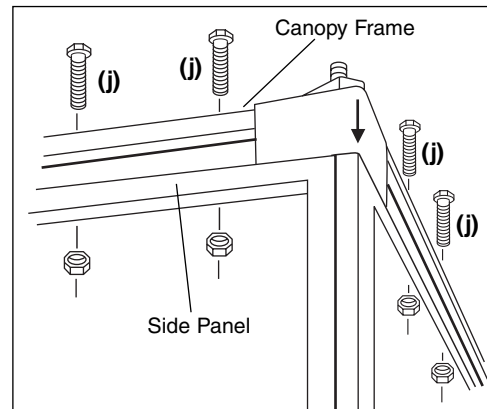

Fig. 14

- Grasp corners of canopy (s) and slide them down to corners of side panels.
- Slip grommet in each corner of canopy (s) over bolt as shown. Secure with acorn nut (f) and tighten. (Fig.15)

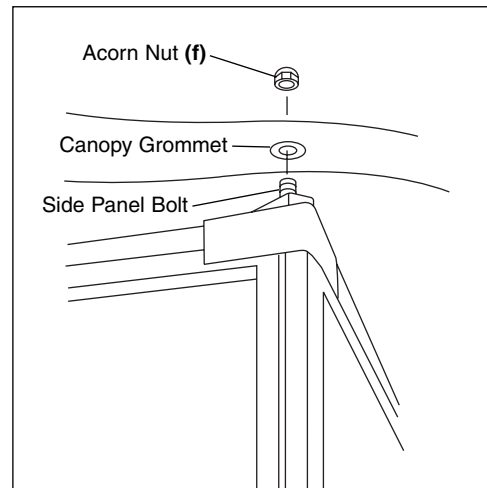

Fig. 15

INSTALLATION INSTRUCTIONS

Side Panel Assembly:

- Using 1 1/2" screws with nuts (j), attach Decorative Side Panel w/T-bar (l) to Decorative Side Panel - flat (m) side as shown. Repeat to form four (4) corner supports for the shelter. (Fig. 1)
- Set assembled corner supports aside, leaving plenty of room to assemble the rest of your shelter.

NOTE: Do not tighten the screws fully. Hand tighten only.

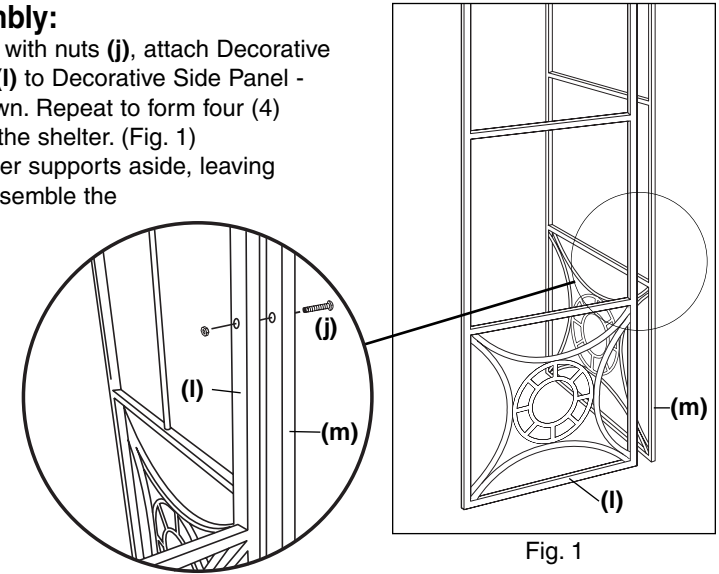

Fig. 1

Canopy Assembly:

- Insert canopy poles (o & p) into canopy hub (a). Insert long canopy poles (o) into long receptors; short canopy poles (p) into short receptors. (Fig. 2)

NOTE: Make sure screw holes on (o) are positioned closer to hub.

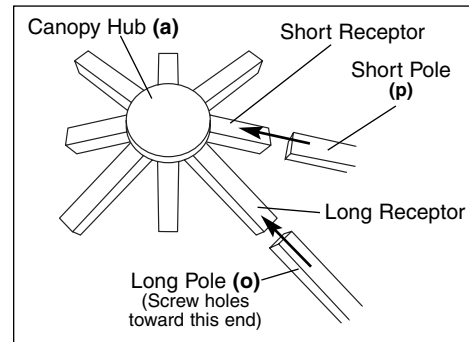
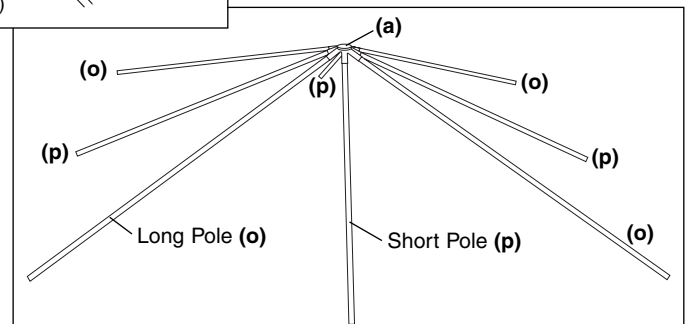

Fig. 2



Canopy Assembly: (continued)

- Slide canopy (s) over canopy poles as shown. (Fig. 3). Do not attach to side panels at this time.

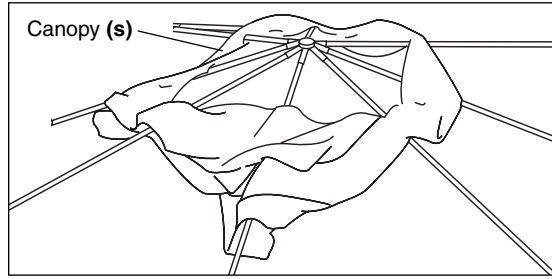

Fig. 3

- Snap 4 vent poles (q) into vent hub (d) as shown. (Fig. 4)

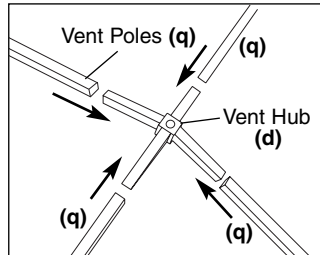

Fig. 4

- Using 1" screws and nuts (i), attach vertical T's on vent poles (q) to long canopy poles (o). Make sure to attach all T's to the same side of the canopy poles (eg. All on right side or all on left side). (Fig. 5)

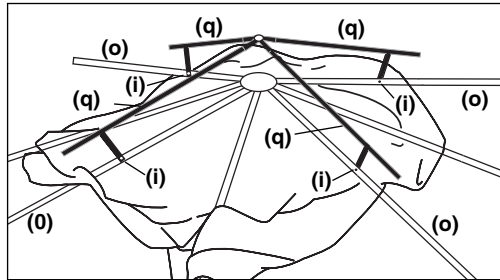

Fig. 5

- Snap on 4 sidewall brackets (g) on end of short canopy poles (p) (Fig. 6) and corner brackets w/screw (e) on end of 4 long canopy poles (o) (Fig. 7).

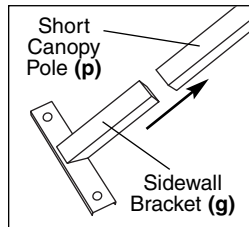

Fig. 6

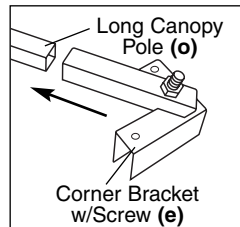

Fig. 7

Canopy Assembly: (continued)

- Attach vent cover (r) to assembled vent hub/frame by sliding bolt (c) through hub and grommet in vent cover. Pull fabric pockets in corners of vent canopy over ends of vent poles (q) (Fig. 8). Screw on finial (b) to secure (Fig. 9).

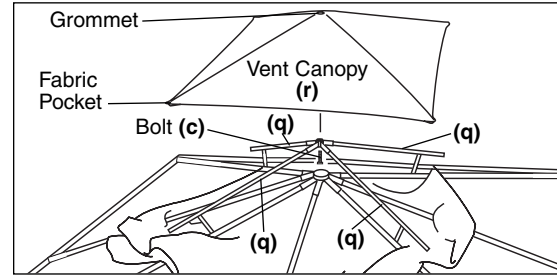

Fig. 8

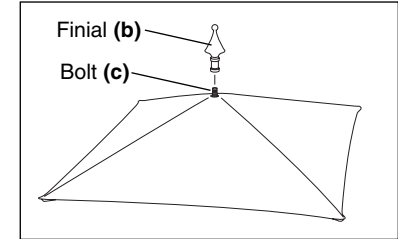

Fig. 9

- Attach one end of eave pole (n) to corner brackets w/screw (e). Secure by using 1/2" screws (k) (no nut) (Fig. 10)

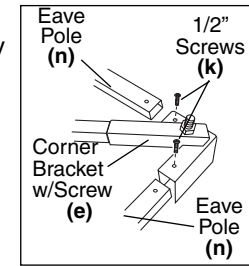

Fig. 10

- Connect other end of eave pole (n) to sidewall bracket (g) using tie plate (h) and 1" screws with nuts (i). (Fig. 11)

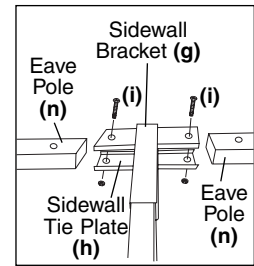

Fig. 11

Attach Canopy Assembly to Side Panel Assemblies:

NOTE: It is recommended that you have a minimum of two other persons helping you with this portion of assembly. This will help prevent the canopy or side panels from falling & possibly injuring someone or damaging the structure.

- Move and position 4 side panel assemblies near to each corner of canopy assembly. (Fig. 12)

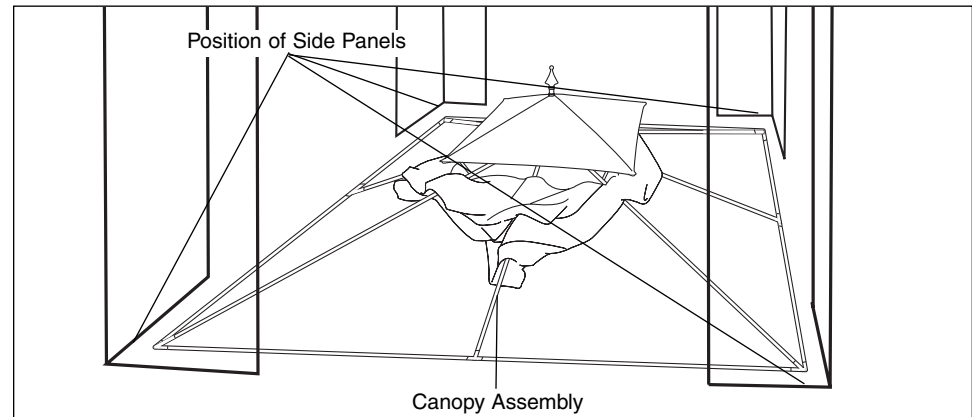

Fig. 12