

SAFE PETS

D E L U X E

**PetSafe**<sup>®</sup>

HAPPY OWNERS

# In-Ground FENCE

Comfort-Fit<sup>™</sup> System

Operating and Training Guide

**LITTLE DOG**



**Please read this entire guide before installation**

Thank you for choosing PetSafe®, the best selling brand of electronic training solutions in the world. Our mission is to be the most trusted brand in the pet ownership experience. We want to ensure your pet's safety by providing you with the tools and techniques to successfully train your pet. If you have any questions, please contact the Customer Care Center at 1-800-732-2677 or visit our website at [www.petsafe.net](http://www.petsafe.net)

To get the most protection out of your limited warranty, please register your product within 90 days at [www.petsafe.net](http://www.petsafe.net). By registering, you will enjoy the product's full warranty and should you ever need to call the Customer Care Center, we will be able to help you faster. Additionally, you will not have to save your product receipt as registering serves as proof of purchase. Most importantly, PetSafe will never give or sell your valuable information to anyone.

---

## Table of Contents

Components .....	3
Other Items You May Need.....	3
How the System Works .....	4
Key Definitions .....	4
<b>Operating Guide</b>	
Locate the Fence Transmitter.....	5
Lay Out the System.....	5
Sample Layouts.....	6
Position the Boundary Wire .....	7
Connect the Wires to the Fence Transmitter .....	8
Prepare the Receiver Collar.....	9
Set the Boundary Width and Test the Receiver Collar.....	10
Install the Boundary Wire .....	11
Place the Boundary Flags .....	12
Fit the Receiver Collar.....	12
<b>Training Guide</b>	
Be Patient With Your Pet .....	13
Day 1 - Boundary Flag Awareness.....	13
Days 2 thru 4 - Continue Boundary Flag Awareness .....	14
Days 5 thru 8 - Distraction Phase .....	15
Days 9 thru 14 - Unleashed Supervision.....	15
Days 15 thru 30 - Pet Monitoring .....	15
Taking Your Pet Out of the Pet Area .....	16
Accessories .....	16
Troubleshooting.....	17
Short Loop Test .....	18
To Locate a Break in the Wire .....	18
Terms of Use and Limitation of Liability .....	19
Caution .....	19
Layout Grid.....	20

# Components

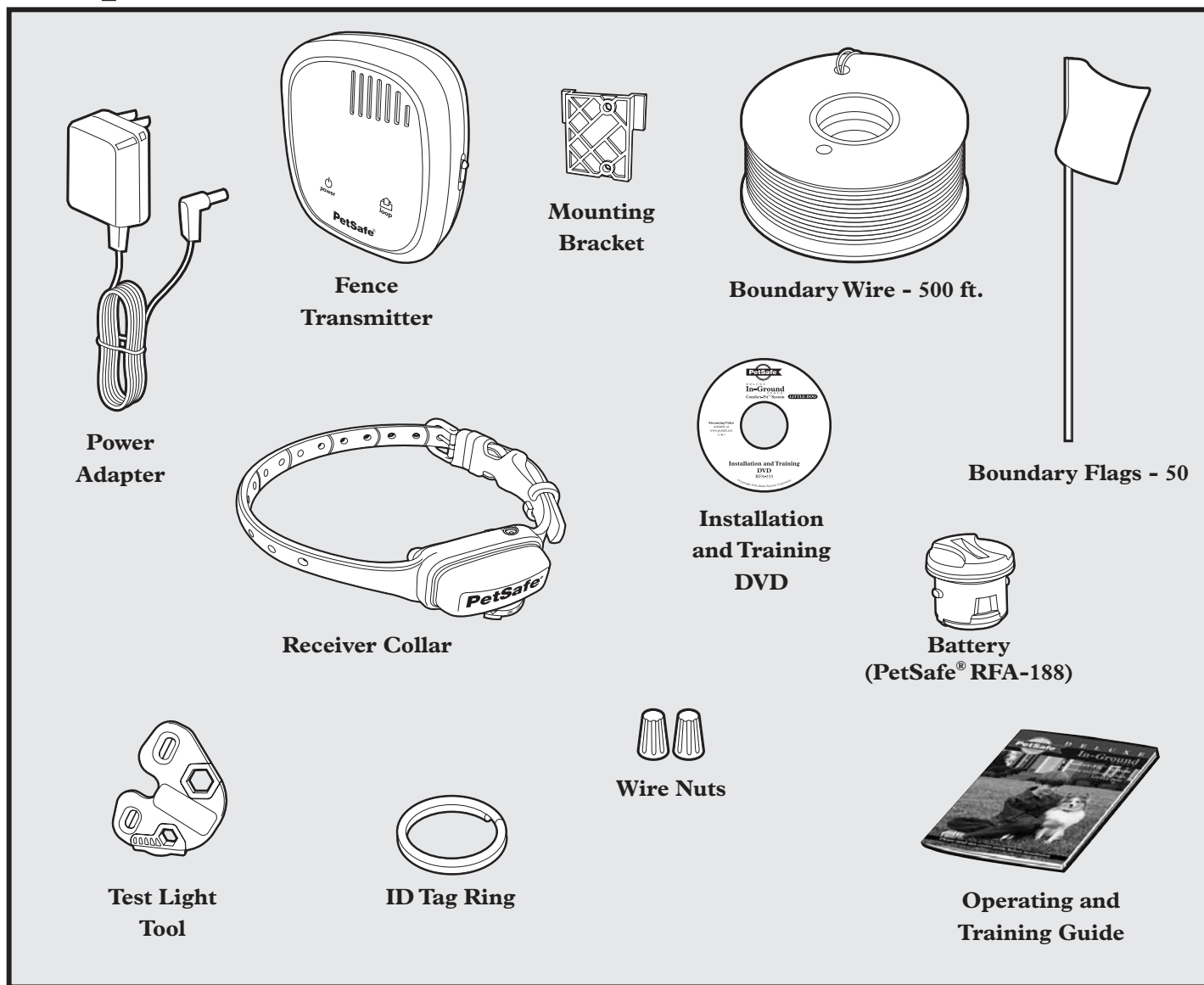

## Other Items You May Need

- Additional wire and flags (Part #PRFA-500)
- Tape measure
- Drill & mounting hardware
- Shovel or lawn edger
- Pliers
- Wire stripping pliers
- Scissors
- Electrical tape
- Additional wire nuts
- Ground rod and clamp
- Waterproofing compound (e.g. silicone caulk)
- PVC pipe or water hose
- Circular saw with masonry blade
- Patching compound
- Staple gun
- Non-metallic collar and leash

*Note: For information on professional installation of your new PetSafe In-Ground Fence™, contact the Customer Care Center at 1-800-732-2677 or visit our website at [www.invisiblefence.com](http://www.invisiblefence.com).*

# How the System Works

The PetSafe® In-Ground Fence™ has been proven safe, comfortable, and effective for all pets up to 55 pounds with neck sizes 6”-26”. The system works by producing a radio signal from the Fence Transmitter through up to 4000 feet of Boundary Wire. The Boundary Wire is buried or attached to a fixed object to enclose the Pet Area. You temporarily define the Pet Area with Boundary Flags for a visual aid in training your pet. Your pet wears a Receiver Collar with Contact Points that touch his neck, and, once trained, is allowed to roam freely in the Pet Area. When your pet reaches the Warning Zone, the Receiver Collar gives a warning beep. If your pet continues into the Static Correction Zone, a safe Static Correction will be delivered through the Contact Points to get his attention until he returns to the Pet Area.

## Key Definitions

**Fence Transmitter:** The device that transmits the radio signal through the Boundary Wire.

**Pet Area:** The area within the Warning Zone where your pet can roam freely.

**Warning Zone:** The outer edge of the Pet Area where your pet’s Receiver Collar begins to beep, warning him not to go into the Static Correction Zone.

**Static Correction Zone:** The zone beyond the Warning Zone where your pet’s Receiver Collar will emit a Static Correction, signaling him to return to the Pet Area.

**Boundary Width:** The combination of the Warning Zone and the Static Correction Zone.

**Receiver Collar:** The device that receives the radio signal from the Boundary Wire.

**Correction Level Button:** The button to adjust the level of Static Correction your pet receives in the Static Correction Zone.

**Receiver Indicator Light:** The light that indicates the level of correction at which the Receiver Collar is set. This light also serves as a low battery indicator.

**Contact Points:** The contacts through which the Receiver Collar delivers the safe Static Correction when your pet moves into the Static Correction Zone.

**Power Jack:** The jack where the Power Adapter plugs into the Fence Transmitter. The Fence Transmitter is powered by a standard 120-volt outlet.

**Boundary Control Switch:** The switch to adjust according to the length of Boundary Wire used.

**Ground Terminal:** The terminal where the Ground Wire connects to the Fence Transmitter.

**Boundary Wire Terminals:** The terminals where the Boundary Wires connect to the Fence Transmitter in order to complete a continuous loop.

**Loop Indicator Light:** The light that indicates that the Boundary Wire makes a complete loop, enabling the signal to be transmitted.

**Boundary Width Control:** The knob that adjusts the width of the Warning and Static Correction Zones. *Note: Adjusting the knob does not change the level of Static Correction on the Receiver Collar.*

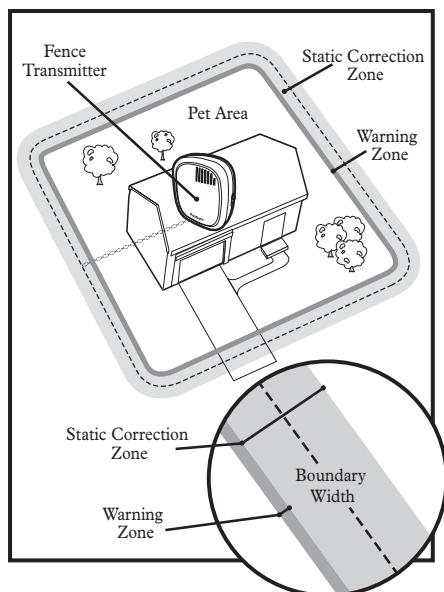

**Receiver Collar**

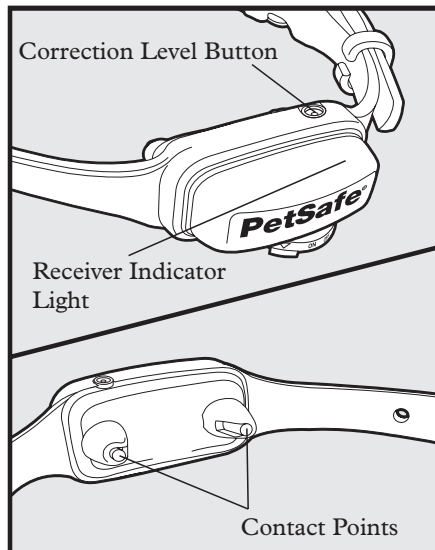

**Fence Transmitter**

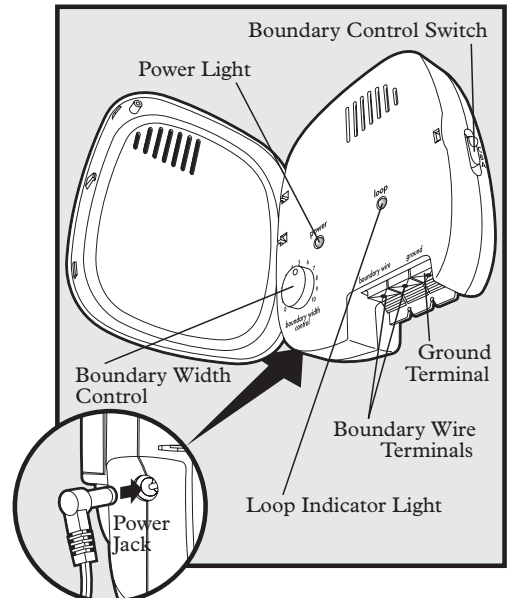

# Operating Guide

## Step 1 Locate the Fence Transmitter

1

Place the Fence Transmitter:

- In a dry, well ventilated, protected area (**1A**, **1B**).
- In an area where temperatures do not fall below freezing (e.g., garage, basement, shed, closet).
- At least 3 feet from large metal objects or appliances as these items may interfere with the signal consistency (**1C**).

To mount the Fence Transmitter, screw the mounting bracket onto a stationary surface such as a wall, and slide the Fence Transmitter onto the bracket. Once you have mounted the Fence Transmitter, the Boundary Wire must exit the building. This can be accomplished via a window or through a 1/8" hole drilled through the wall. Ensure the drill path is clear of any utilities. Make sure the Boundary Wire is not cut off or pinched by a window, door, or garage door, as this can damage it over time.

To prevent fires and electrical hazards, install the Fence Transmitter in buildings that are in accordance with state and local electrical codes.

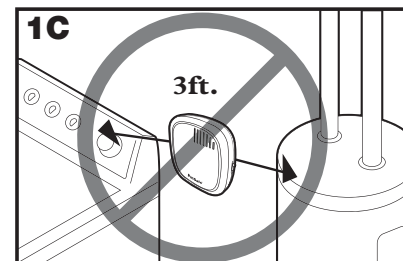
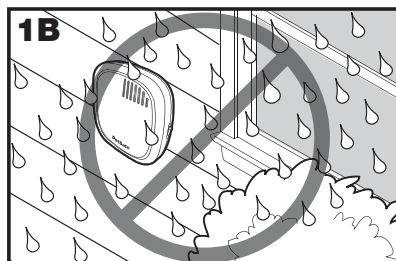
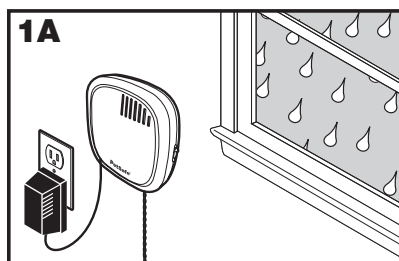

## Step 2 Lay Out the System

2

### Basic Planning Tips

- The Boundary Wire **MUST** start at the Fence Transmitter and make a continuous loop back (**2A**).
- Design a layout that is suitable for your yard. Sample layouts are provided in this section, and a grid for designing your layout is provided in the back of this guide.
- Fence planning software is available online at [www.petsafe.net/fence](http://www.petsafe.net/fence). After you have planned and saved your layout online, contact our Customer Care Center to review and refine your layout.
- Twisting two sides of the Boundary Wire cancels the signal and allows your pet to cross over that area safely. Plastic or metal piping will not cancel the signal. Twist the Boundary Wire 10 to 12 times per foot to cancel the signal (**2A**).
- Always use gradual turns at the corners to produce a more consistent boundary (**2B**). Do not use sharp turns, as this will cause gaps in your boundary.
- Avoid making passageways too narrow for your pet to move about freely (e.g., along the sides of a house).
- The Receiver Collar can be activated inside the house if the Boundary Wire runs along the outside wall of the house. If this occurs, remove your pet's Receiver Collar before bringing him inside, decrease the range using the Boundary Width Control knob or consider an alternative layout.

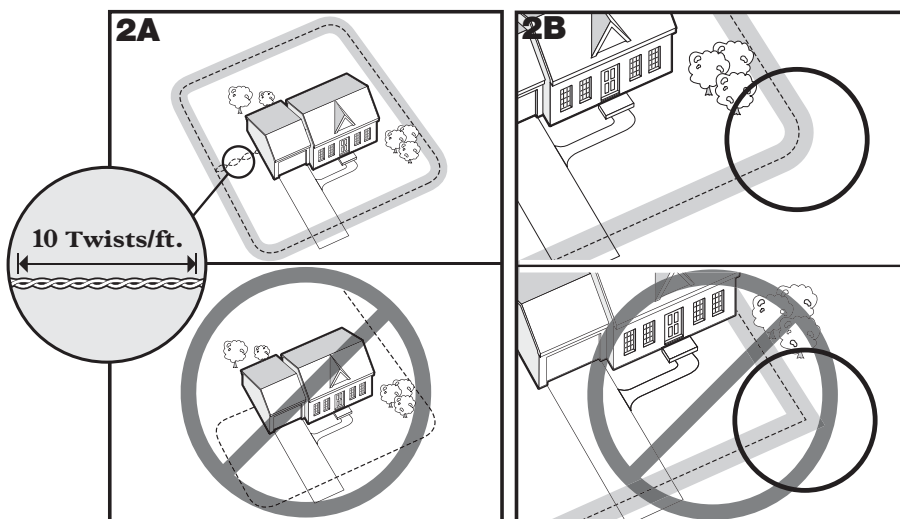

# Sample Layouts

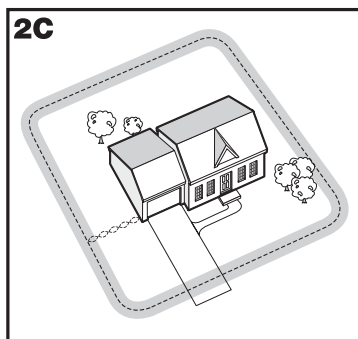

**Sample 1: Perimeter Loop (Single Loop)** The Perimeter Loop is the most common layout. This will allow your pet to freely and safely roam your entire property (2C). It can also protect gardens, pools and landscaping (2D).

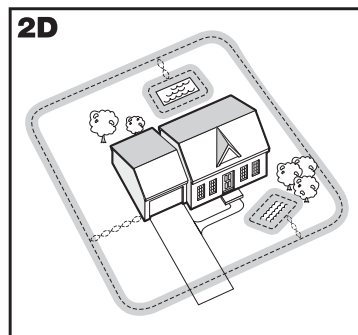
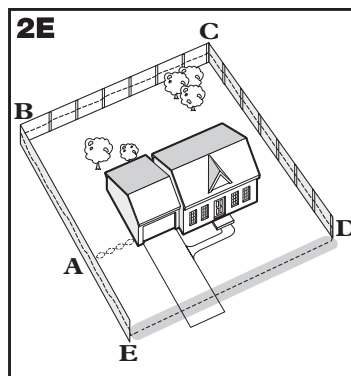

## Sample 2 (2E): Perimeter Loop Using Existing Fence (Single Loop)

This layout allows you to include your existing fence as part of your layout and keep your pet from jumping out or digging under your existing fence. It reduces the amount of wire which will need to be buried. From the Fence Transmitter, run the wire to **A**, **A** to **B**, **B** to **C**, **C** to **D**, **D** to **E**, **E** to **A**, twist the wires from **A** back to the Fence Transmitter. See the “Install the Boundary Wire” section for more information on attaching the wire to a fence.

## Double Loop

A Double Loop must be used when you are not establishing the Boundary Zone on all sides of your property.

When using a Double Loop, the Boundary Wire must be separated by a minimum of **THREE TO FIVE FEET** to avoid canceling the signal. Remember that a Double Loop will require twice as much wire.

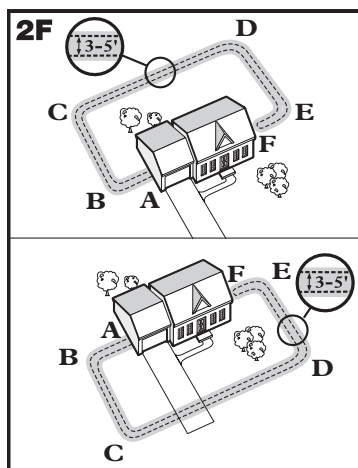

## Sample 3 (2F): Front or Back Yard Only (Double Loop)

From the Fence Transmitter, run the wire to **A**, **A** to **B**, **B** to **C**, **C** to **D**, **D** to **E**, **E** to **F**, make a U-turn and follow your path all the way back to **A**, keeping the wire separated **three to five feet**. Twist the wire from **A** back to the Fence Transmitter.

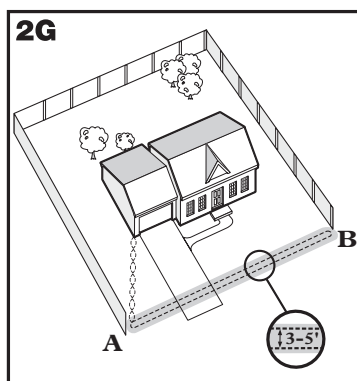

## Sample 4 (2G): Front Boundary Only (Double Loop)

From the Fence Transmitter, run the wire to **A**, **A** to **B**, **B** back to **A** keeping the wire separated **three to five feet**. Twist the wire from **A** back to the Fence Transmitter.

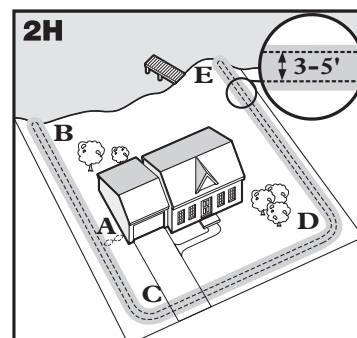

## Sample 5 (2H): Lake Access (Double Loop)

From the Fence Transmitter, run the wire to **A**, **A** to **B**, make a U-turn and go to **C**, **C** to **D**, **D** to **E**, make a U-turn and follow your path all the way back to **A** keeping wire separated **three to five feet**. Twist the wire from **A** back to the Fence Transmitter.

### Sample 6 (2J): Wire Loop Attached to Existing Fence (Double Loop)

This layout allows you to include your existing fence as part of your layout and keep your pet from jumping out or digging under your existing fence. It reduces the amount of wire which will need to be buried. Run the wire from the Fence Transmitter to **A**, **A** to **B**, **B** to **C**, **C** to **D**, **D** to **E**, **E** to **F**, make a U-turn and follow your path all the way back to **A**, keeping the wire separated **three to five feet**. Twist the wire from **A** back to the Fence Transmitter. See the “Install the Boundary Wire” section for more information on attaching the wire to a fence.

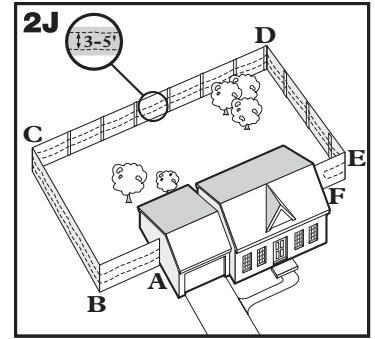

## Step 3 Position the Boundary Wire

**Lay out the Boundary Wire using your proposed boundary and test the system BEFORE burying the wire or attaching it to an existing fence. This will make any layout changes easier.**

Running the Boundary Wire parallel to and within five feet of electrical wires, neighboring containment systems, telephone wires, television or antenna cables, or satellite dishes will cause an inconsistent signal. If you must cross any of these, do so at 90-degree angles (perpendicularly).

If separating your Boundary Wire by at least five feet from a neighboring containment system's wire does not reduce the inconsistent signal, contact the Customer Care Center at 1-800-732-2677.

### To Twist the Boundary Wire (3A)

Twisting the Boundary Wire cancels the signal and allows your pet to cross over that area safely. Plastic or metal piping will not cancel the signal. Twist the Boundary Wire 10 to 12 times per foot to cancel the signal. The maximum length of twisted wire is 50 feet.

### To Splice or Repair the Boundary Wire (3B)

If you need additional Boundary Wire to expand your wire loop, you will need to splice the wires together. Note the locations of all splices for future reference. Most Boundary Wire breaks occur at splices.

Strip approximately one-half inch of insulation off the ends of the Boundary Wires to be spliced. Make sure the copper Boundary Wire is not corroded. If the Boundary Wire is corroded, cut it back to expose clean copper wire.

Insert the stripped ends into the wire nut and twist the wire nut around the wires. Pull on the wires to make sure you have a strong splice connection. Apply waterproofing compound (e.g. silicone caulk) in and around the wire nut or wrap the wires and the wire nuts with electrical tape to prevent moisture from corroding the copper.

If your splice pulls loose, the entire system will fail. Make sure your splice is secure.

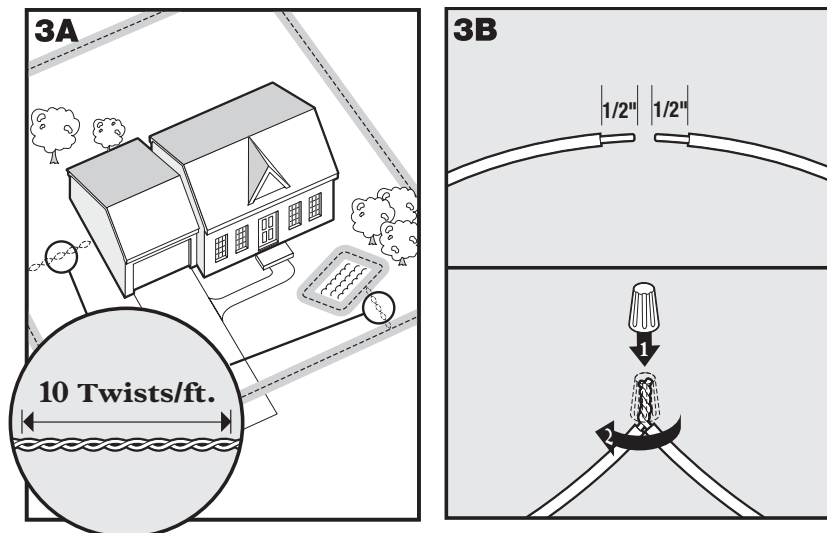

## Additional Boundary Wire

We recommend the use of 20 gauge insulated multi-strand copper wire for direct burial. Extra Boundary Wire can be purchased in 500 foot spools at the store where you purchased the kit or through the Customer Care Center at 1-800-732-2677.

*Note: When adding Boundary Wire, it must act as a continuous loop.*

The table at right indicates the approximate length of Boundary Wire needed for a rectangular, Single Loop layout. Length will vary due to the amount of twisted wire and layout used. Remember that a Double Loop will require twice as much wire.

Acres	Feet of Wire Needed
1/4	415
1/3	480
1/2	590
1	835
2	1180
5	1870
10	2800
25	4000

# Step 4 Connect the Wires to the Fence Transmitter

## Boundary Wire (4A)

1. Run the Boundary Wire to the Fence Transmitter through a window, under a door, through a crawl space vent, or any other appropriate available access. You can also drill a hole through your wall.
2. Strip the ends of the Boundary Wire approximately one-half inch.
3. Insert the Boundary Wires into the Boundary Wire Terminals on the Fence Transmitter.
4. Turn the Boundary Width Control knob to 10. This will set the Warning Zone at the maximum width.
5. Plug the Power Adapter into the Power Jack and a 120-volt outlet.
6. The Power Light and Loop Indicator Lights should come on. If this does not happen, see the "Troubleshooting" section.

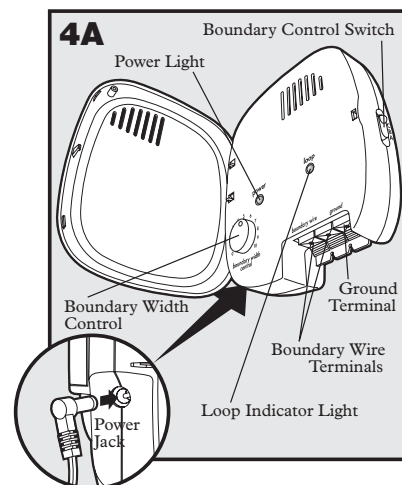

## Ground Wire (4B)

Proper grounding, although not necessary for the system to work, will help reduce the chance of electrical surges causing damage to your Fence Transmitter and/or Power Adapter. To ground your unit, you will need a solid (not stranded) Ground Wire (14 to 18 gauge insulated copper wire) and a ground rod with clamp, which may be obtained at most electrical supply stores. Connect one end of the Ground Wire to the Ground Terminal located on the Fence Transmitter and the other end of the Ground Wire to the ground rod. The ground rod must be buried at least three feet into the ground and located as close as possible to the Fence Transmitter.

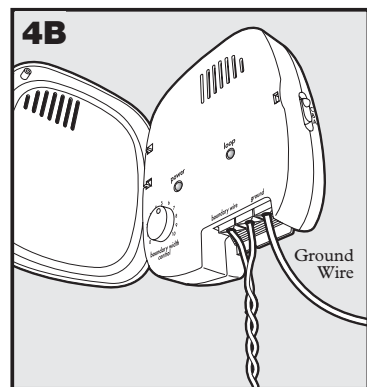

## Fuse Protection (4C)

The Fence Transmitter is also equipped with a 250 volt, 1/2 amp fuse to protect the unit's electronic circuitry from electrical power surges. To locate the fuse, slide off the lid on the back of the Fence Transmitter. A spare fuse is also provided.

## Lightning Protection

You may purchase a Lightning Protection Kit through the Customer Care Center at 1-800-732-2677. The Lightning Protection Kit protects the system against surges that travel through the power source and/or the Boundary Wire. If you use a Lightning Protection Kit, the Ground Wire must be removed from the Fence Transmitter. The Lightning Protection Kit utilizes a ground connection separate from the Fence Transmitter.

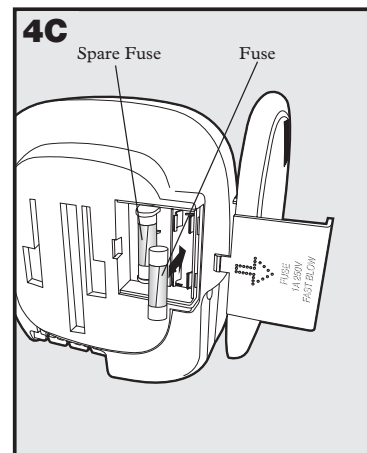



# Step 5 Prepare the Receiver Collar

# 5

## To Insert and Remove the Battery

*Note: Do not install the battery while the Receiver Collar is on your pet.*

This Receiver Collar utilizes a replaceable PetSafe® battery (RFA-188). This unique battery is designed to make battery replacement easier and increase water protection.

To activate the collar, insert the battery module (5A). Using the edge of the Test Light Tool as shown, turn the battery clockwise until the vertical line on the battery is pointed to the “ON” position (5B). If the PetSafe® Receiver Collar is not going to be used on the pet immediately, leave it in the “OFF” position.

To remove the battery, turn the battery counter-clockwise using the edge of the Test Light Tool as shown (5C, 5D). DO NOT attempt to cut into or pry open the battery. Be sure to discard the used battery properly.

A replacement PetSafe® battery can be found at many retailers. Contact the Customer Care Center at 1-800-732-2677 or visit our website at [www.petsafe.net](http://www.petsafe.net) to locate a retailer near you.

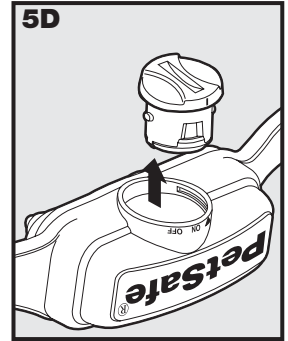
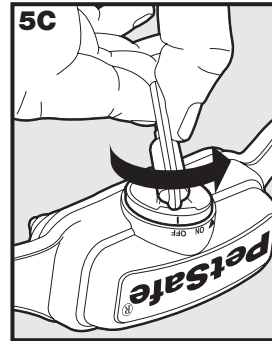
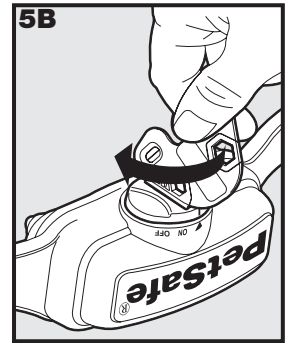
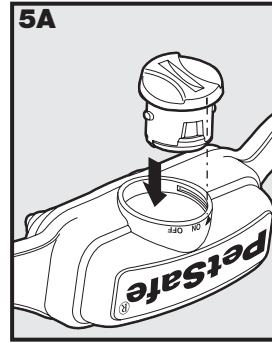

## Two Color LED

The two color LED indicator shows good or low battery. Good battery equals 1 flash every 60 seconds with Green LED. Low battery equals 3 flashes every 60 seconds with the Red LED. If there are no LED lights it is time to change the battery.

## To Set the Static Correction Level

Read all steps before attempting to set the Static Correction Level.

1. With the battery installed, press the Correction Level Button and release when the Receiver Indicator Light lights red (5E).
2. The Receiver Indicator Light will emit a number of red flashes representing the Static Correction Level (5F).
3. Increase the Static Correction Level by pressing and releasing the Correction Level Button within 5 seconds of the previous flashes.

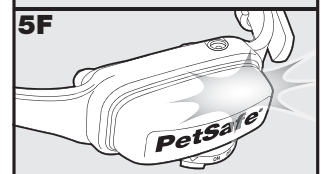
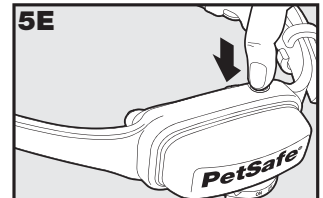

The Static Correction Levels increase from 1 to 5. Pushing the Correction Level Button while the Receiver Collar is on level 5 will cause the Receiver Collar to revert to level 1. Refer to the Function and Response Table to choose the Static Correction level that best fits your pet.

The Receiver Collar is equipped to automatically increase the level of Static Correction the longer your pet remains in the Static Correction Zone if the collar is set at level 2 or above.

The Receiver Indicator Light acts as a low battery indicator, flashing every 60 seconds when battery replacement is required.

## Function and Response Table

*Note: Begin training with Static Correction Level 2 and only increase if your pet does not respond to the Static Correction.*

Indicator Light Response	Static Correction Level	Receiver Collar Function	Temperament of Pet
1 Red Flash	1	No Static Correction, Tone Only	
2 Red Flashes	2	Low Static Correction	Timid
3 Red Flashes	3	Medium Static Correction	Timid or Average
4 Red Flashes	4	Medium High Static Correction	Average or High Energy
5 Red Flashes	5	High Static Correction	High Energy
Flashes 3 Red Flashes every 60 seconds	Low Battery		

# Step 6 Set the Boundary Width and Test the Receiver Collar

The Boundary Control Switch on the side of the Fence Transmitter has three settings (6A). Setting **B** is used for most properties. The following table will indicate the setting you should use.

Amount of Wire	Setting
Up to 1300 feet	<b>B</b>
1300-2400 feet	<b>C</b>
Greater than 2400 feet	<b>A</b>

Use the Boundary Width Control knob to set the width of the Warning Zone and Static Correction Zone (6B). Set the Boundary Width as wide as possible to give your pet the widest Warning and Static Correction Zones without reducing the Pet Area too much.

*Note: The Boundary Width Control knob does not change the Static Correction Level.*

To identify the Warning and Static Correction Zones, make sure the Receiver Collar battery is properly installed, the Static Correction Level is set at 2 or above, and the Test Light contacts are held to the Contact Points (6C). Walk toward the Boundary Wire holding the Receiver Collar at your pet's neck level (6D) until the Receiver Collar beeps (6E).

*Note: The Receiver Collar is waterproof, which can make the beep hard to hear.*

If the Receiver Collar does not beep at the desired range, adjust the Boundary Width Control knob to the desired setting. Turning the Boundary Width Control knob clockwise increases the Boundary Width while turning it counterclockwise decreases it (6B). Repeat this activity as needed until the Receiver Collar beeps at the desired distance from the Boundary Wire.

The numbers on the Boundary Width Control knob indicate signal strength and are not representative of Boundary Width footage. If adjusting the Boundary Width Control knob does not give the desired range, adjust the Boundary Control Switch to another setting to achieve your desired range. If using a Double Loop, you may need to increase the separation of the Boundary Wire to achieve the desired range.

The Receiver Collar beeps as a warning tone and ticks when delivering a Static Correction. After hearing the beep, continue to walk towards the wire. The Receiver Collar should tick and the Test Light should flash, indicating the Static Correction as you enter the Static Correction Zone (6E). A warning beep and the flashing of the Test Light indicate that the Receiver Collar and the system are working properly and that you are ready to start burying the Boundary Wire. If the Receiver Collar did not beep or the Test Light did not flash, refer to the "Troubleshooting" section.

*Note: The Boundary Width is broken down into 20% Warning Zone and 80% Static Correction Zone.*

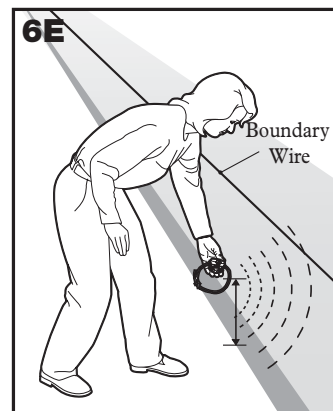
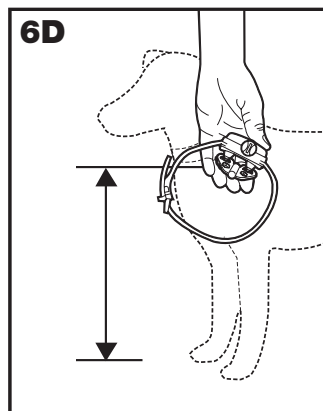
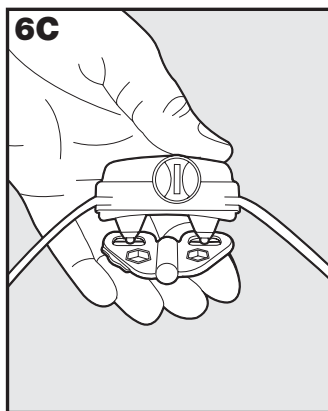
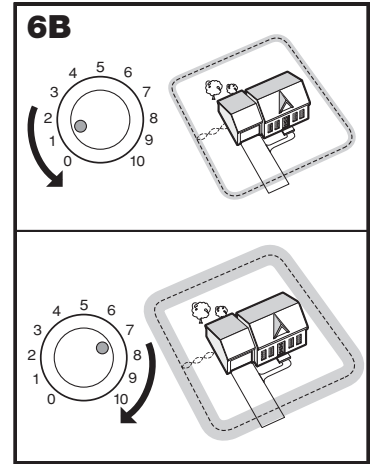
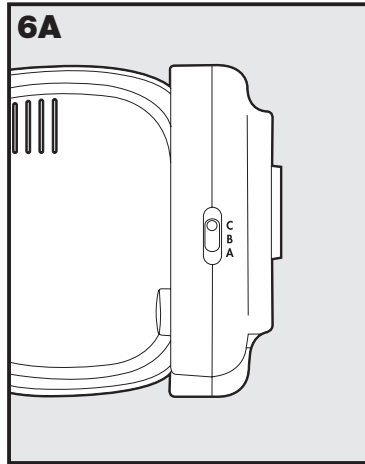

# Step 7 Install the Boundary Wire

## To Bury the Boundary Wire

Burying the Boundary Wire is recommended to protect it and prevent disabling the system.

1. Cut a trench **1-3 inches** deep along your planned boundary.
2. Place the Boundary Wire into the trench maintaining some slack to allow it to expand and contract with temperature variations.
3. Use a blunt tool such as a wooden paint stick to push the Boundary Wire into the trench. Be careful not to damage the Boundary Wire.

## To Attach the Boundary Wire to an Existing Fence

The Boundary Wire of the PetSafe® In-Ground Fence™ can be attached to a chain link fence, split rail fence, or a wooden privacy fence. The Boundary Wire can be attached as high as needed. However, make sure the Boundary Width is set at a high enough range for the pet to receive the signal. If using a Double Loop with an existing fence at least three feet tall, run the Boundary Wire on top of the fence and return it on the bottom of the fence to get the three to five foot separation needed.

- **Chain Link Fence (7A):** Weave Boundary Wire through the links or use plastic quick ties.
- **Wooden Split Rail or Privacy Fence (7A):** Use staples to attach Boundary Wire. Avoid puncturing the insulation of the Boundary Wire.
- **Double Loop with an Existing Fence:** Run Boundary Wire on top of the fence and return it on the bottom of the fence to get the three to five foot separation needed.
- **Gate (Single Loop) (7B):** Bury the Boundary Wire in the ground across the gate opening.  
*Note: The signal is still active across the gate. Your pet cannot pass through an open gate.*
- **Gate (Double Loop) (7B):** Bury both Boundary Wires across the gate opening while keeping them three to five feet apart.

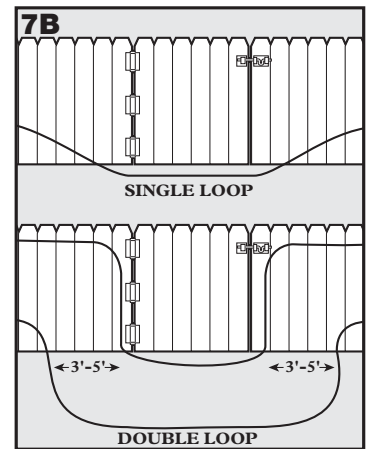
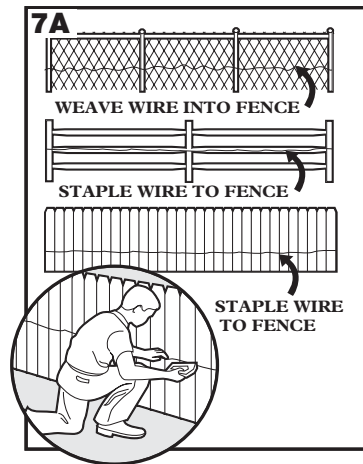

## To Cross Hard Surfaces (driveways, sidewalks, etc.)

- **Concrete Driveway or Sidewalk (7C):** Place the Boundary Wire in a convenient expansion joint or create a groove using a circular saw and masonry blade. Place the Boundary Wire in the groove and cover with an appropriate patching compound. For best results, brush away dirt or other debris before patching.
- **Gravel or Dirt Driveway (7D):** Place the Boundary Wire in a PVC pipe or water hose to protect the Boundary Wire before burying.

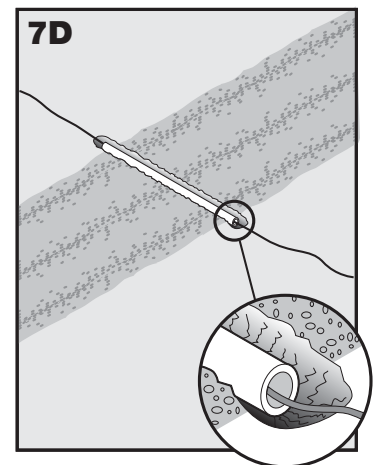
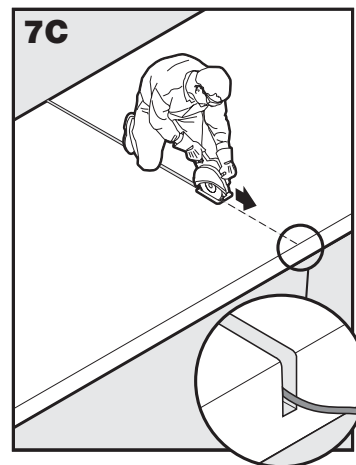

## Step 8 Place the Boundary Flags

8

The Boundary Flags are visual reminders for your pet of where the Warning Zone is located.

1. Hold the Receiver Collar at your pet's neck height.
2. Walk towards the Warning Zone until the Receiver Collar beeps (8A).
3. Place a Boundary Flag in the ground (8B).
4. Walk back into the Pet Area until the beeping stops.
5. Repeat this process around the Warning Zone until it is marked with Boundary Flags every 10 feet.

*Note: If you cannot hear the beep, see the Test Light Instructions in Step 6.*

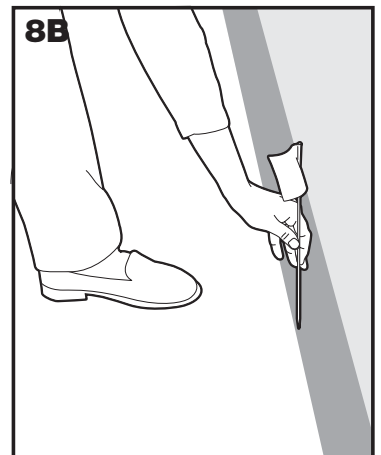

## Step 9 Fit the Receiver Collar

9

**Important: The proper fit and placement of your Receiver Collar is important for effective operation. The Contact Points must have direct contact with your pet's skin on the underside of his neck.**

To assure a proper fit, please follow these steps:

1. Make sure that the battery is not installed in the Receiver Collar.
2. Have your pet standing comfortably (9A).
3. Center the Contact Points underneath your pet's neck, touching the skin (9B).

*Note: It is sometimes necessary to trim the hair around the Contact Points to make sure that contact is consistent.*

4. The PetSafe® QuickFit™ Collar is designed so you can quickly attach and remove the Receiver Collar from your pet while maintaining the desired fit.

- a. With the Snap Buckle fastened (9C), thread the collar through the Metal Buckle (9D).
- b. Slide the excess collar through the "C" Loop on top of the Snap Buckle. This will hold the excess collar in place.
- c. Once the collar fit is determined, use the Snap Buckle to remove and replace the collar.

5. The Receiver Collar should fit snugly, yet loose enough to allow one finger to fit between a Contact Point and your pet's neck (9E). Allow your pet to wear the collar for several minutes, then recheck the fit. Check the fit again as your pet becomes more comfortable with the Receiver Collar.

6. Trim the collar as follows:

- a. Mark the desired length of the collar with a pen. Allow for growth if your pet is young or grows a thick winter coat.
- b. Remove the Receiver Collar from your pet and cut off excess.

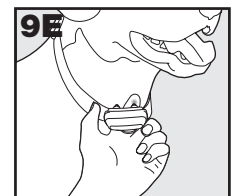
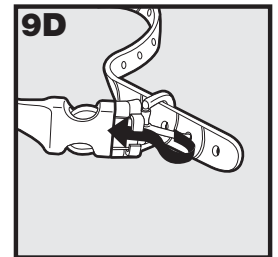
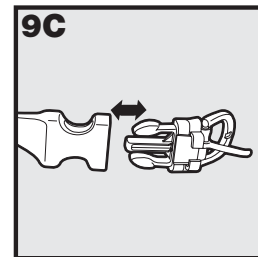
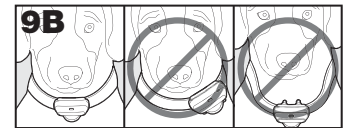
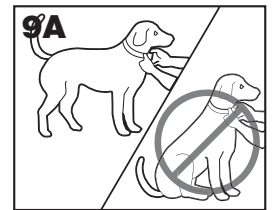

### ID Tag Ring

Use the ID Tag Ring to attach your pet's ID tags to the collar. Simply place the ID Tag Ring through one of the holes on your collar. Make sure to place the Ring far enough from receiver housing so that tags will not hit the Receiver or the Contact Points (9F).

**Important: Do not attach a leash to the collar. This can result in pulling the Contact Points too tightly against your pet's neck. Attach a leash to a separate, non-metallic collar or harness, making sure the extra collar does not put pressure on the Contact Points.**

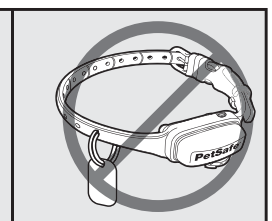
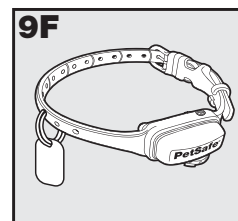

**Important: For comfort, safety and effectiveness of product, please ensure the following:**

- Check the fit to prevent excessive pressure by being able to insert one finger between the Contact Point and your pet's skin.
- Your pet must be carefully examined daily for any signs of a rash or sore.
- If a rash or sore is observed, discontinue the use of the Receiver Collar for a few days.
- If the condition persists beyond 48 hours, see your veterinarian.
- Your pet's neck and the Contact Points must be washed weekly with a wash cloth and mild hand soap, then rinsed thoroughly.

A condition called Pressure Necrosis, which is a devitalization of the skin due to excessive and prolonged contact against the Contact Points, may occur if the steps above are not followed.

# Training Guide

## Be Patient With Your Pet

**Important: Proper training of your pet is essential to the success of the PetSafe® In-Ground Fence™. Read this section completely before beginning to train your pet. Remember that the PetSafe In-Ground Fence is not a solid barrier.**

- Have fun with your pet throughout the training process. Training should be fun, fair, firm and consistent.
- Train for 10 to 15 minutes at a time. Don't try to do too much too quickly. More-frequent short sessions are better than less-frequent longer sessions.
- If your pet shows signs of stress, slow down the training schedule, add additional days of training, or increase the amount of play time with your pet in the Pet Area. Common stress signals include:
  - Pet pulling on leash toward the house
  - Ears tucked
  - Tail down
  - Body lowered
  - Nervous / frantic movement or stiffening of pet's body
- Your pet must be completely comfortable near the Boundary Flags at the end of every training session. Spend at least 5 minutes of "play time" at the completion of each session within 10 feet of the Boundary Flags.
- Finish each training session on a positive note with lots of praise and play.
- Remove the Receiver Collar after each training session.
- Be sure to contain your pet by another means during the training period (e.g. pen, tie-out, leash, etc.).
- During training, if you need to take your pet out of the Pet Area, remove the Receiver Collar and either pick your pet up or put him in the car to pass out of the Pet Area.
- Even if you think your pet is responding well to the training, complete the entire training. Reinforcement is important!

## Phase 1 Day 1 - Boundary Flag Awareness

Perform three sessions on day one, each training session lasting 10-15 minutes.

### **Goal:**

To have your pet learn that the Boundary Flags and warning beep from the Receiver Collar define the new Pet Area.

### **Setup:**

- Program the Receiver Collar to level #2 or #3 depending on the size and temperament of your pet and place it on your pet's neck.
- Put a separate non-metallic collar on your pet's neck ABOVE the Receiver Collar and attach a leash. *Note: Be sure the extra collar does not put pressure on the Contact Points.*
- Have tiny pieces of treats that your pet will find desirable available (hot dogs or lunch meat work well).
- Have your pet's favorite play toy available.

**Steps:**

1. Begin by walking your pet on a leash in the Pet Area. Calmly praise and talk to your pet, occasionally giving treats.
2. Move toward the Boundary Flags (10A). Keep your mood happy and throw treats to the ground.
3. With full control of your pet on a leash, toss a treat on the outside edge of the flags. As your pet enters the Static Correction Zone to receive the treat, he will begin to receive a mild Static Correction (10B). The longer your pet remains in the Static Correction Zone, the stronger the Static Correction will get. Allow him to stay in the Static Correction Zone for 2 seconds then gently help your pet back into the Pet Area (10C). Immediately praise and offer him a treat as he enters the Pet Area, even if you have helped with the leash. Wiggle a Boundary Flag to help your pet understand that the discomfort of the Static Correction happens around the flags.
4. Repeat this process at several different Boundary Flags. Your pet should start to resist going after the treat in the Static Correction Zone. If your pet continues to enter the Static Correction Zone, check the fit of his Receiver Collar and allow him 2-3 seconds in the zone before pulling him back to the Pet Area.

*Note: Never allow your pet to eat the treat in the Static Correction Zone.*

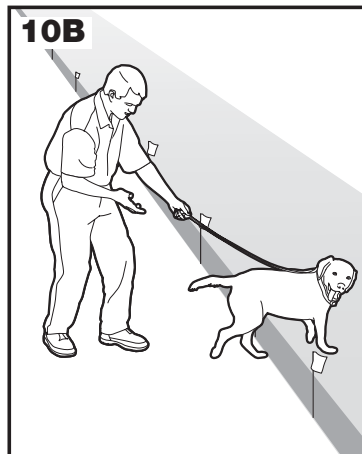
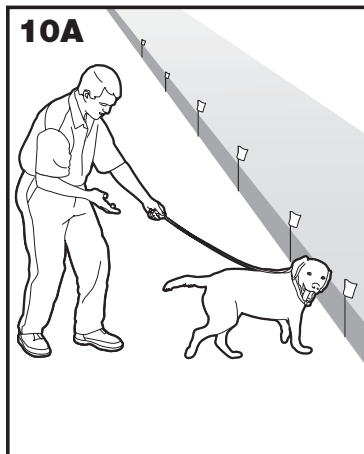

## Phase 2 Days 2 thru 4 - Continue Boundary Flag Awareness

Perform three sessions per day, each lasting 10-15 minutes.

**Goal:**

To train your pet to stay in the Pet Area and respect the boundary while you are outside of it.

**Setup:**

- Program the Receiver Collar to level #3 or #4 depending on the size and temperament of your pet and place it on your pet's neck.
- Put a separate non-metallic collar on your pet's neck ABOVE the Receiver Collar and attach a leash. *Note: Be sure the extra collar does not put pressure on the Contact Points.*
- Have tiny pieces of treats available (hot dogs or lunch meat work well).
- Have your pet's favorite play toy available.

**Steps:**

1. Repeat steps 1-4 in Phase One
2. Drop the leash, leaving your pet in the Pet Area.
3. Walk outside the boundary and wiggle the Boundary Flags facing your pet.
4. Continue around the entire boundary doing this, tossing treats to your pet in the Pet Area and praising him.

## Phase Days 5 thru 8 - Distraction Phase

# 3

Perform three training sessions per day, each lasting 10 to 15 minutes.

### **Goal:**

To train your pet to stay within the Pet Area with distractions outside of the Pet Area.

### **Setup:**

- Program the Receiver Collar to level #3 or #4 depending on the size and temperament of your pet.
- Put a separate non-metallic collar on your pet's neck ABOVE the Receiver Collar and attach a leash. *Note: Be sure the extra collar does not put pressure on the Contact Points.*
- Have tiny pieces of treats available (hot dogs or lunch meat work well).
- Have your pet's favorite play toy available.
- Create distractions to tempt your pet to enter the Warning and Static Correction Zones, such as:
  - Have a family member cross from inside the Pet Area to outside of it.
  - Throw a ball outside of the Pet Area.
  - Have a neighbor walk their pet outside of the Pet Area.

### **Steps:**

1. With full control of your pet on a leash, have the distraction presented.
  2. If your pet does not move toward the distraction, praise and offer a treat.
  3. If your pet does react to the distraction, allow him to go into the Static Correction Zone.
  4. Help your pet back into the Pet Area if he does not turn back after 3 seconds.
  5. Treat and praise your pet anytime he comes back into the Pet Area with or without help.
  6. Repeat this process with other distractions. Use other family members during this process.
- 

## Phase Days 9 thru 14 - Unleashed Supervision

# 4

Training sessions should start at 10-15 minutes, gradually increasing to over an hour.

Your pet is ready for this step only when he clearly avoids the entire Boundary Flag line, regardless of any distractions or temptations. During this step, do not leave your pet unattended.

### **Goal:**

To give your pet free run of the Pet Area off the leash.

### **Setup:**

Adjust the Receiver Collar to the permanent setting appropriate for your pet depending on his size and temperament.

### **Steps:**

1. Enter the Pet Area with your pet wearing the Receiver Collar.
  2. Walk around the yard and play with your pet, staying within the Pet Area at all times.
  3. Preoccupy yourself with another task in the yard while watching your pet.
  4. Should your pet escape, take the Receiver Collar off or turn the system off at the Fence Transmitter and lead him back into the Pet Area.
- 

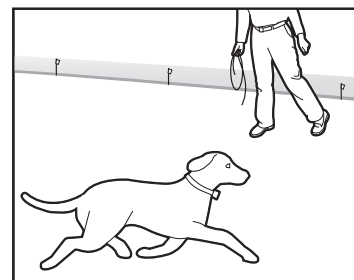

## Phase Days 15 thru 30 - Pet Monitoring

# 5

Your pet is ready to run! Check in on your pet at regular intervals.

*Note: After you are satisfied your pet's training is complete, remove every other Boundary Flag every 4 days until all flags are removed. Save Boundary Flags for future use.*

# Taking Your Pet Out of the Pet Area

**Important: Remove the Receiver Collar and leave it in the Pet Area.**

Once your pet learns the Boundary Zone, he will be reluctant to cross it for walks or car rides.

**Option 1:** Replace the Receiver Collar with a regular collar. Put your pet in a car that is within the Pet Area and drive him out of the Pet Area.

**Option 2:** Replace the Receiver Collar with a regular collar and leash. Walk your pet out of the Pet Area while giving a command such as “OK” at a specific place of the Boundary Zone (the end of your driveway, sidewalk, etc.). Always leave the Pet Area with a leash at this place and your pet will associate leaving the Pet Area only on a leash, only at this place, and only with a person. You may initially need to convince your pet to leave the Pet Area with a food treat and lots of praise.

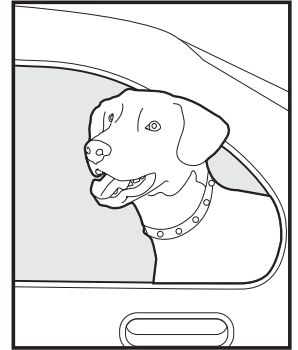

*Note: You may also carry your pet out of the Pet Area.*

***Congratulations! You have now successfully completed the training program.***

---

## Accessories

To purchase additional accessories for your PetSafe® In-Ground Fence™, contact the Customer Care Center at 1-800-732-2677 or visit our website at [www.petsafe.net](http://www.petsafe.net) to locate a retailer near you.

<b>Component</b>	<b>Part Number</b>
Battery	RFA-188
Power Adapter for the Fence Transmitter	RFA-14
Lightning Protection Kit	RFA-28
Installation & Training Video (DVD)	RFA-235
Additional Receiver Collar	PIG00-10778
Additional Boundary Wire	RFA-1
Additional Boundary Flags	RFA-2
Wire & Flag Accessory Kit	PRFA-500
Fence Transmitter	300-395
Wire Break Locator	RFA-50

If the collar breaks, you have to replace the whole Receiver Collar. Please contact the Customer Care Center for replacement collar and instructions.



# Troubleshooting

<p><b>Receiver Collar is not beeping or correcting.</b></p>	<ul style="list-style-type: none"> <li>• Check battery to make sure it is installed properly.</li> <li>• Check that both lights are lit on the Fence Transmitter. If not, perform the “Short Loop Test”.</li> </ul>
<p><b>The Receiver Collar is beeping, but the pet is not responding to the Static Correction.</b></p>	<ul style="list-style-type: none"> <li>• Make sure the Static Correction Level is set at 2 or above.</li> <li>• Test the Receiver Collar with the Test Light.</li> <li>• If the Test Light flashes, check the fit of the Receiver Collar.</li> <li>• Trim your pet’s hair where the Contact Points touch his neck.</li> <li>• Increase the Static Correction Level.</li> <li>• Repeat training steps to reinforce training.</li> <li>• Purchase a stronger Receiver Collar by contacting the Customer Care Center at 1-800-732-2677.</li> </ul>
<p><b>The Receiver Collar has to be held on top of the Boundary Wire to activate.</b></p>	<ul style="list-style-type: none"> <li>• Replace battery.</li> <li>• Adjust Boundary Width Control knob clockwise to increase the distance from the Boundary Wire that the Receiver Collar activates.</li> <li>• Adjust the Boundary Control Switch to another setting.</li> <li>• If using a Double Loop, make sure Boundary Wires are separated 3 to 5 feet.</li> <li>• If the Receiver Collar still has to be held on top of the Boundary Wire, perform the “Short Loop Test.”</li> </ul>
<p><b>The Receiver Collar activates inside the house.</b></p>	<ul style="list-style-type: none"> <li>• Turn the Boundary Width Control knob counterclockwise to decrease the distance from the Boundary Wire that the Receiver Collar activates.</li> <li>• Make sure the Boundary Wire is not running too close to the house. The signal can transmit through the walls of your house.</li> <li>• Make sure Boundary Wires are twisted from Boundary to the Fence Transmitter.</li> </ul>
<p><b>I have an inconsistent signal.</b></p>	<ul style="list-style-type: none"> <li>• Make sure Fence Transmitter is at least 3 feet from large metal objects or appliances.</li> <li>• Make sure all Boundary Wire turns are gradual.</li> <li>• Make sure the Boundary Wire is not running parallel to and within 5 feet of electrical wires, neighboring containment systems, telephone wires, television or antenna cables, or satellite dishes.</li> <li>• If a neighboring containment system may be causing an inconsistent signal, contact the Customer Care Center at 1-800-732-2677 to see if a different frequency system will help your situation.</li> </ul>
<p><b>The Power and Loop Indicator Lights are off.</b></p>	<ul style="list-style-type: none"> <li>• Check that the Power Adapter is plugged into the Fence Transmitter.</li> <li>• Try plugging into another 120-volt outlet.</li> <li>• Remove the fuse door on the back of the Fence Transmitter and change out the fuse with the spare one located in the same area.</li> <li>• If the lights still do not come on, the Fence Transmitter and/or Power Adapter needs to be replaced. Contact the Customer Care Center at 1-800-732-2677.</li> </ul>
<p><b>The Power Light is on, the Loop Indicator Light is off, and the Fence Transmitter loop alarm is sounding.</b></p>	<ul style="list-style-type: none"> <li>• Make sure both ends of the Boundary Wire are plugged into Boundary Wire Terminals and that ½ inch of the insulation is stripped so that the copper wire is exposed.</li> <li>• Perform the “Short Loop Test” to determine if the Fence Transmitter needs to be replaced or if the Boundary Wire is broken.</li> <li>• If the Fence Transmitter is functioning properly, you have a break in your Boundary Wire. See the “Locating a Break in the Wire” section in this guide.</li> </ul>
<p><b>The fuse blows when it is replaced.</b></p>	<ul style="list-style-type: none"> <li>• The Fence Transmitter and/or Power Adapter needs to be replaced. Contact the Customer Care Center at 1-800-732-2677.</li> </ul>

# Additional Information

- The Boundary Wire is buried so that it is not accidentally tripped over or cut. Use care when using a weed eater or when digging near the Boundary Wire to prevent damage.
- The system should only be used with healthy pets. Contact your veterinarian if you have concerns about the medical condition of your pet (medication, pregnant, heart conditions, etc.).
- This system is not for vicious or aggressive pets. If your pet may pose a threat to others, **DO NOT USE THIS SYSTEM.** If you are unsure if your pet is aggressive, please consult your veterinarian or a certified trainer.
- The PetSafe® In-Ground Fence™ is for residential use only.
- The Static Correction will get your pet's attention, but will not cause harm. It is designed to startle, not to punish.
- Test the Receiver Collar every 2 months. Battery life depends upon how often the Receiver Collar is activated.

## Short Loop Test

The Short Loop Test is a simple test to determine if each component (Fence Transmitter, Receiver Collar and Boundary Wire) is functioning properly.

1. Disconnect the Boundary Wire and Ground Wire.
2. Cut approximately 10 feet of unused Boundary Wire and connect it to the Boundary Wire Terminals.
3. Spread the Boundary Wire out into a circle. Set the Boundary Control Switch to **B**.
4. Set the Boundary Width Control knob to 10 and the Static Correction Level to level 2 or above.
5. If the Loop Indicator Light is not lit, then your Fence Transmitter is not functioning properly. Contact the Customer Care Center at 1-800-732-2677.
6. If the Loop Indicator Light is lit, disconnect one end of the Boundary Wire from the Boundary Wire Terminal.
7. If the loop alarm does not sound, the Fence Transmitter needs to be replaced. Contact the Customer Care Center at 1-800-732-2677.
8. If the loop alarm does sound, plug the Boundary Wire back into the Boundary Wire Terminal.
9. Hold the Receiver Collar next to the 10-foot length of Boundary Wire. The Receiver Collar should beep about one foot away from the Boundary Wire.
10. Hold the Test Light contacts to the Contact Points. The Test Light should flash when you hold the Receiver Collar close to the Boundary Wire.
11. If Receiver Collar does not beep and the Test Light does not flash, replace the battery in the Receiver Collar. If it still does not beep and the Test Light does not flash, contact the Customer Care Center at 1-800-732-2677.
12. If the Receiver Collar beeps, there may be a complete or partial break in the Boundary Wire. See the "To Locate a Break in the Boundary Wire" section.

## To Locate a Break in the Boundary Wire

Please follow these steps in determining where you have a break in your Boundary Wire:

1. Locate your original splice(s) and verify they have a good, solid connection.
2. Check your yard to determine any possible damage to the Boundary Wire (e.g. recent digging, aerating, rodent burrowing, or any other noticeable disturbance in your yard next to the Boundary Wire).

If you still cannot find the break in the Boundary Wire, there are two options for locating it:

**Option 1:** Contact the Customer Care Center at 1-800-732-2677 to purchase a Wire Break Locator that will locate the break in the Boundary Wire.

**Option 2:** Follow the procedure below:

1. Unplug the Fence Transmitter.
2. Connect both ends of your twisted Boundary Wire to one Boundary Wire Terminal.
3. Measure and cut a Test Wire which is half the length of your total Boundary Wire footage.
4. Connect one end of the Test Wire to the other Boundary Wire Terminal.
5. Locate the halfway point of your boundary and cut the Boundary Wire.
6. Splice the other end of the Test Wire to either side of your Boundary Wire where you cut it in half.
7. Plug in the Fence Transmitter and check the Loop Indicator Light. If the Loop Indicator Light is on you can assume the break is in the other half of the Boundary Wire.
8. If the Loop Indicator Light did not come on, you may assume there is a break in this portion of the Boundary Wire. However, there is a small chance of having more than one break in your system. Be sure to check both halves of your entire loop.
9. Replace the damaged Boundary Wire with new Boundary Wire.

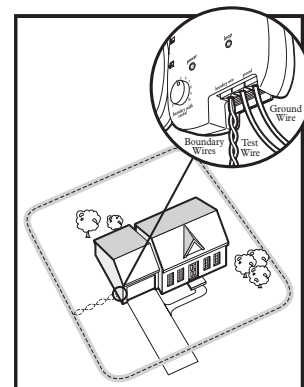

10. Reconnect the Boundary Wire to the Fence Transmitter.
  11. Check the Loop Indicator Light. If the Loop Indicator Light is on, test the system with the Receiver Collar.
- 

## Terms of Use and Limitation of Liability

### 1. Terms of Use

This Product is offered to you conditioned upon your acceptance without modification of the terms, conditions and notices contained herein. Usage of this Product implies acceptance of all such terms, conditions, and notices.

### 2. Proper Use

This Product is designed for use with pets where training is desired. The specific temperament of your pet may not work with this Product. If you are unsure whether this is appropriate for your pet, please consult your veterinarian or certified trainer.

Proper use includes reviewing the entire Guide provided with your Product and any specific Caution statements.

### 3. No Unlawful or Prohibited Use

This Product is designed for use with pets only. This pet training device is not intended to harm, injure or provoke. Using this Product in a way that is not intended could result in violation of Federal, State or local laws.

### 4. Limitation of Liability

In no event shall Radio Systems® Corporation be liable for any direct, indirect, punitive, incidental, special or consequential damages, or any damages whatsoever arising out of or connected with the use or misuse of this Product. Buyer assumes all risks and liability from the use of this Product.

### 5. Modification of Terms and Conditions

Radio Systems Corporation reserves the right to change the terms, conditions and notices under which this Product is offered.

---

## FCC

This equipment has been tested and found to comply with the limits for a Class B digital device, pursuant to Part 15 of the FCC Rules. These limits are designed to provide reasonable protection against harmful interference when the equipment is operated in a residential environment. This equipment generates, uses, and can radiate radio frequency energy and, if not installed and used in accordance with the instruction guide, may cause harmful interference to radio communications. However, there is no guarantee that interference will not occur in a practical installation. If this equipment causes harmful interference to radio or television reception, which can be determined by turning the equipment off and on, the user is encouraged to try to correct the interference by one or more of the following measures:

- Relocate the interfered receiving antenna.
- Increase the separation between the equipment and receiver.
- Connect the equipment into an outlet on a circuit different to that to which the receiver is connected.
- Contact the Customer Care Center at 1-800-732-2677.

Unauthorized changes or modifications to the equipment, not approved by Radio Systems Corporation, could result in not meeting compliance with FCC regulations and could void the user's authority to operate the equipment.

---

## Caution

The PetSafe® In-Ground Fence™ is NOT a solid barrier. The system is designed to act as a deterrent to remind pets by electric stimulation to remain in the boundary established. It is important that you reinforce training with your pet on a regular basis. Since the tolerance level to electrical stimulation varies from pet to pet, Radio Systems Corporation CANNOT guarantee that the system will, in all cases, keep a pet within the established boundary. Not all pets can be trained to avoid crossing the boundary! Therefore, if you have reason to believe that your pet may pose a danger to others or harm himself if he is not kept from crossing the boundaries, you should NOT rely solely upon the PetSafe In-Ground Fence to confine your pet. Radio Systems Corporation shall NOT be liable for any property damage, economic loss or any consequential damages, sustained as a result of any animal crossing the boundary.

# Product Warranty

Please register your product online at [www.petsafe.net](http://www.petsafe.net). All parts are covered under warranty for the life of this product. Labor is covered for the first year of ownership. Thereafter, there is a minimum service charge for the repair or replacement of the product. Misuse, loss, damage by pet or improper use or handling is not covered. PetSafe® will not pay for loss of time, inconvenience, loss of use of your product or any incidental or consequential damage. Warranty void if product resold.

Please contact the Customer Care Center at 1-800-732-2677 if you need service or for help in troubleshooting and, if needed, to arrange a repair for your product (a service charge may apply.) Also, please visit our website [www.petsafe.net](http://www.petsafe.net) for Frequently Asked Questions and Troubleshooting Tips.

---

# Perchlorate Battery

Perchlorate Material – special handling may apply. See [www.dtsc.ca.gov/hazardouswaste/perchlorate](http://www.dtsc.ca.gov/hazardouswaste/perchlorate).







# Layout Grid

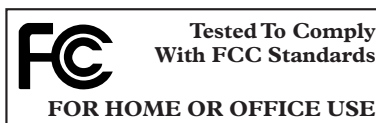
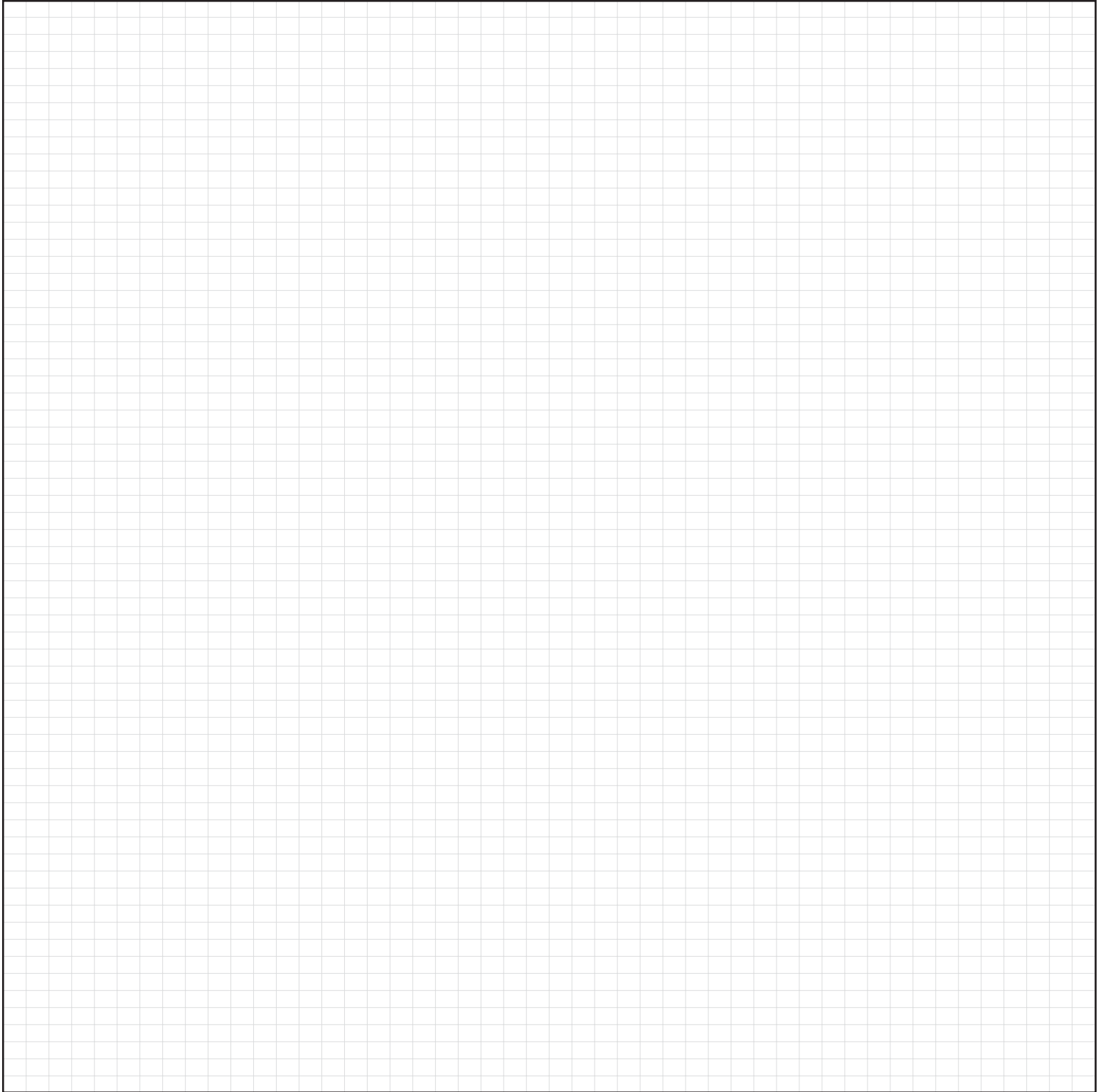

Radio Systems Corporation  
10427 Electric Avenue  
Knoxville, TN 37932  
1-800-732-2677  
[www.petsafe.net](http://www.petsafe.net)  
400-802/4

Covered by US Patent 6,921,089, other patents pending  
©Copyright 2007, Radio Systems Corporation