

# **PetSafe® Pawz Away™ Extra Outdoor Pet Barrier**

## **Operating and Training Guide**

**Please read this entire guide before beginning.**

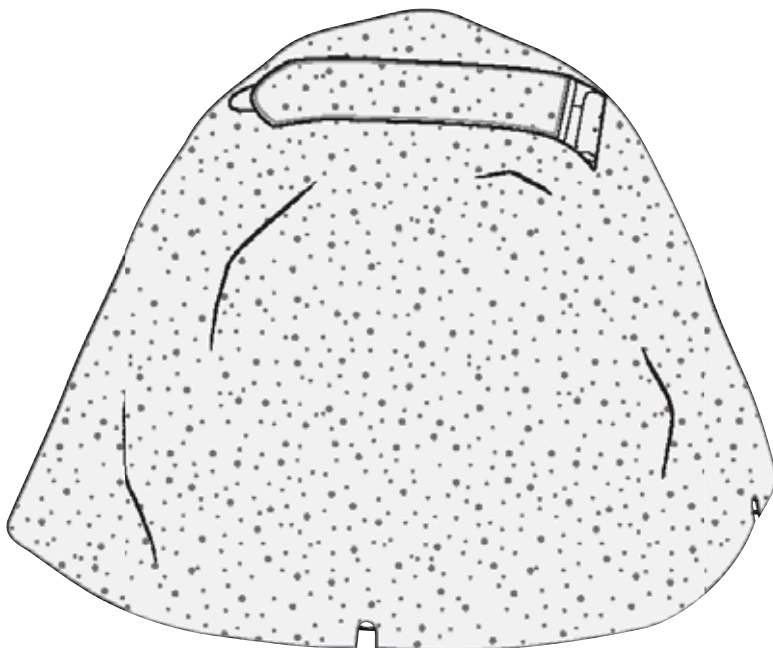

Thank you for choosing PetSafe®, the best selling brand of electronic training solutions in the world. Our mission is to be the most trusted brand in the pet ownership experience. We want to ensure your pet's safety by providing you with the tools and techniques to successfully train your pet. If you have any questions, please contact the Customer Care Center at 1-800-732-2677 or visit our website at [www.petsafe.net](http://www.petsafe.net).

To get the most protection out of your warranty, please register your product within 30 days at [www.petsafe.net](http://www.petsafe.net). By registering and keeping your receipt, you will enjoy the product's full warranty and should you ever need to call the Customer Care Center, we will be able to help you faster. Most importantly, PetSafe® will never give or sell your valuable information to anyone. Complete warranty information is available online at [www.petsafe.net](http://www.petsafe.net).

---

## Table of Contents

|   |    |
|---|----|
| How the Pawz Away™ Outdoor Pet Barrier Works.....             | 3  |
| <b>Operating Guide - Wireless Option</b> .....                | 4  |
| Power Up the Barrier Transmitter .....                        | 4  |
| Set Up the Barrier Transmitter.....                           | 4  |
| Test the Barrier Area .....                                   | 4  |
| <b>Operating Guide - Wire Option</b> .....                    | 6  |
| Determine Placement of Barrier Transmitter & Wire Layout..... | 6  |
| Connect the Wires to the Barrier Transmitter.....             | 7  |
| Test the Barrier Area .....                                   | 8  |
| Install the Boundary Wire .....                               | 8  |
| <b>Training Guide</b> .....                                   | 10 |
| Begin Your Pet's First Session .....                          | 10 |
| Further Training.....   | 10 |
| Additional Information.....                                   | 10 |
| <b>Troubleshooting</b> .....                                  | 11 |
| Terms of Use and Limitation of Liability .....                | 12 |
| Compliance .....  | 12 |
| Customer Care International .....                             | 13 |
| Caution .....   | 13 |

# How the Pawz Away™ Outdoor Pet Barrier Works

The Barrier Transmitter, disguised as a rock in your landscape, sends a spherical radio signal up to 16 feet in diameter or an 8 foot radius. Your pet wears a Receiver Collar with Contact Points that touch his neck. When your pet enters the Barrier Area, he'll hear a series of audible tones from the Receiver Collar and he will feel a safe progressive Static Correction, delivered through the Contact Points on his neck. It is designed to startle, not to punish. The progressive Static Correction will get your pet's attention, but will not cause harm. The correction continues until your pet leaves the Barrier Area. The system has been proven safe, comfortable and effective for pets at least 6 months old and over 5 pounds.

You also have the option to create a custom shaped barrier using Boundary Wire. Create a barrier loop up to 150 feet.

**Warning: This is a deterrence system designed to keep pets away from areas in your landscape you want to protect. THIS IS NOT A CONTAINMENT SYSTEM. Do not use this system to keep your pet contained in your yard. The static correction is not intended to keep your pet contained.**

# Operating Guide - Wireless Option

## Step 1 Power Up the Barrier Transmitter

1 Locate the battery door on the bottom of the Barrier Transmitter. Loosen the 4 Phillips head screws. The screws will stay in the battery lid. Install 4 alkaline D-batteries and replace the battery door.

Under normal conditions, the batteries will operate the transmitter for up to one year. Test the system every few months to ensure it is working properly.

## Step 2 Set Up the Barrier Transmitter

**Important: Never perform set-up procedures while your pet is wearing the Receiver Collar.**

1. Turn the Barrier Transmitter upright and open the lid exposing the LCD display and range buttons.
2. Press the up (+) button once to turn ON the Barrier Transmitter. A black segment in the bottom of the LCD display indicates the unit is set to the lowest range (1A).
3. Each segment represents approximately two feet of diameter. You can create a Barrier Area up to 16 feet in diameter. Using the up (+) and down (-) buttons, adjust the range to fit the desired pet Barrier Area.

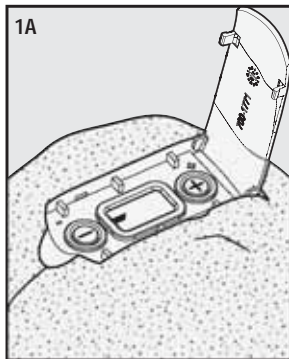

## Step 3 Test the Barrier Area

1. Place the Test Light Tool that came with your system on the Receiver Collar Contact Points. Hold the Receiver Collar at the approximate height of your dog's neck and with the Contact Points facing up (2A). Start outside of the range and walk slowly toward the Barrier Transmitter. As you reach the Barrier Area, the Receiver Collar emits a series of high-pitched tones. For each tone you hear, you should notice the Test Light flashing which indicates that a progressive Static Correction is being delivered. The Receiver Collar's tone is easily heard by dogs but may be at a volume level difficult for some humans to hear.
2. Check the range of the Barrier Area from multiple angles to ensure you are getting the desired coverage.

If you place the Barrier Transmitter close to your house, the signal may transmit through a wall. Be sure to test the receiver collar inside your home.

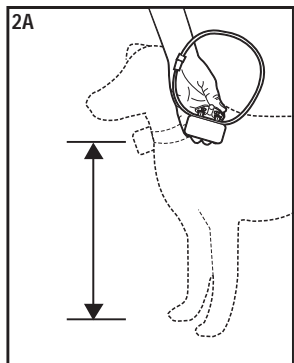

**Important:** Should you find that you are not getting the desired range at the maximum setting, move the Barrier Transmitter a few feet. A variety of factors can affect the magnetic field. For best results, place the Barrier Transmitter on a non-conductive surface, i.e., lawn or landscape bed. Metal objects may distort the Barrier Area size.

**Do not:**

- Place Barrier Transmitter on metal surfaces.
- Place Barrier Transmitter near large metal objects such as heating and air conditioning units, metal outbuildings, metal trash cans, etc.
- Place the Barrier Transmitter in a location where it may become submerged in water. The transmitter is designed to be water resistant and is not waterproof.
- For the longest battery life, avoid exposing the transmitter to extreme temperatures for any extended time.

# Operating Guide - Wire Option

You can customize the size and shape of your barrier. This section discusses laying an external wire which attaches to the Barrier Transmitter. The signal will transmit through the wire, instead of through the Barrier Transmitter, at a range up to 12 feet from the outside of the wire.

You can create a barrier using up to 150 feet of Boundary Wire. Use wire that is rated for direct burial. PetSafe® Boundary Wire can be purchased in 150 foot spools through the Customer Care Center.

## Step 1

## Determine Placement of Barrier Transmitter & Wire Layout

### Basic Planning Tips

**Warning:** Before installing the Boundary Wire, make sure that there are no buried power, telephone, or other electrical cables in the vicinity. Many underground cables carry high voltage and digging into them, or laying your Boundary Wire on them, may lead to hazard from shock or electrocution. Have the local utility company mark your underground lines. In most communities this is a free service.

When determining your wire layout it is important to remember that you will need to set the range to a minimum of 3 segments (3A) when using the wire option. The segments indicate the barrier range. If the range is set to 1 or 2 segments, the signal will not be great enough to be picked up by the Receiver Collar. Refer to the chart below for the approximate range of the signal from the outside of the wire for each segment.

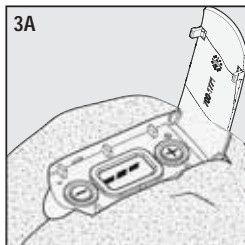

| Segment | Range from Wire |
|---------|-----------------|
| 3       | 3 feet          |
| 4       | 5 feet          |
| 5       | 8 feet          |
| 6       | 12 feet         |

The range will vary depending on the type of layout. Once you lay out your desired barrier continue to Step 2 and 3 before burying the wire. It is important that you test the system and make adjustments to your layout before burying the boundary wire. This will make any layout changes easier. Work carefully. A nick in the wire insulation can diminish the signal strength and create a weak area where your pet can enter the barrier area.

### Additional tips for laying out your boundary wire:

- Always use gradual turns (**3B**) at the corners with a minimum of 3 foot radius to produce a more consistent boundary. Do not use sharp turns (**3C**), as this may cause gaps in your boundary.
- Avoid making passageways too narrow for your pet to move about freely (e.g., along the sides of a house).

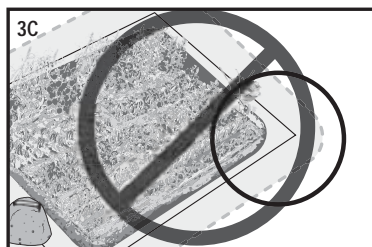
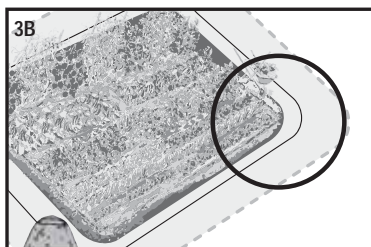

## Sample Layouts

### Perimeter Loop (Single Loop)

The Perimeter Loop is the most common layout. This will allow your pet to freely and safely roam your entire property while protecting gardens (**3D**), children's play areas (**3E**) and landscaping.

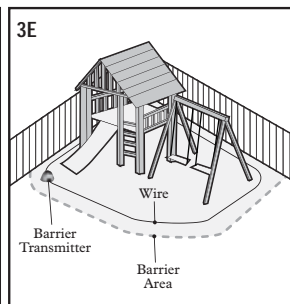
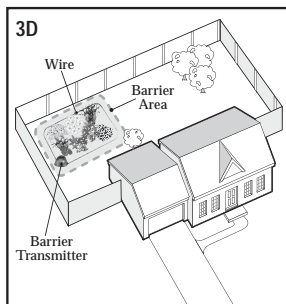

## Step 2 Connect the Wires to the Barrier Transmitter

1. Remove the battery door from the Barrier Transmitter by loosening the 4 phillips head screws. Remove the 4 D-batteries if you had already placed them inside the transmitter.
2. Locate the switch inside the battery cavity. This switch allows the Barrier Transmitter to operate as a wireless (internal antenna) or wired (external antenna) unit. Move the switch to the "External" option so that the radio signal is sent through the wire (**4A**).
3. Using the wire stripping pliers, strip about  $\frac{1}{4}$  inch of insulation from the ends of the Boundary Wire. Use pliers to bend each end of the wire to form a 90 degree angle (**4B**).

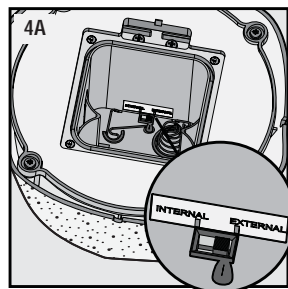

- Place one end of the Boundary Wire into the Boundary Wire Channel on the Barrier Transmitter. The wire should touch the threads of one of the screws in the channel. Once you have placed the wire, tighten the screw (4C).

Repeat this step to connect the other end of the boundary wire to the opposite side of the second screw. Make sure the bare wires do not touch each other.

- Place the batteries back into the transmitter and carefully bend the wires so they fit through the groove on the battery door (4D).

**Be careful not to pull or tug on the wires once you have placed them in the channels.**

- Screw the battery door in place and position the Barrier Transmitter in your landscape.

Under normal conditions, the batteries will operate the transmitter for up to one year. Test the system every few months to ensure it is working properly.

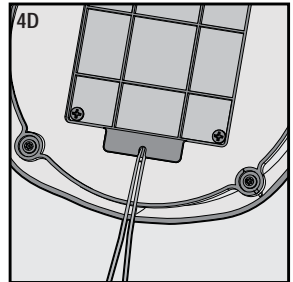
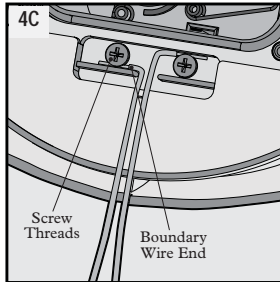
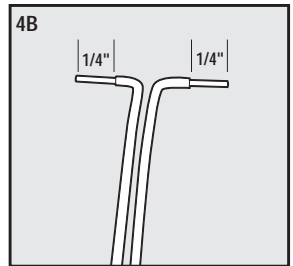

## Step 3 Test the Barrier Area

Refer to Step 3 on page 4 for instructions on how to test the Barrier Area. Keep the following in mind when testing the range using the wire option:

- Start with the range set to 3 segments and adjust the range up to 6 segments to get your desired coverage. Press the (+) button 3 times to set the range to 3 segments.
- When holding the Receiver Collar to check the range, walk toward the Boundary Wire instead of the Barrier Transmitter.

Once you are satisfied that your system is functioning properly and you are receiving the desired barrier coverage, you are ready to bury the Boundary Wire. If the Receiver Collar did not beep or the Test Light did not flash, see the "Troubleshooting" section.

## Step 4 Install the Boundary Wire

For best results, bury the Boundary Wire to protect it. The Boundary Wire can be placed under mulch, however, be sure that the Boundary Wire is placed in low traffic areas to reduce the risk of wire damage.

### To Bury the Boundary Wire

- Cut a trench 1-3 inches deep along your planned boundary.
- Place the Boundary Wire into the trench maintaining some slack to allow it to expand and contract with temperature variations.
- Use a blunt tool such as a wooden paint stick to push the Boundary Wire into the trench. Be careful not to damage the Boundary Wire insulation.



## To Attach the Boundary Wire to an Existing Fence

The Boundary Wire can be attached to a chain link fence, split rail fence, or a wooden privacy fence. The Boundary Wire can be attached as high as needed. However, make sure the Boundary Range is set high enough for the pet to receive the signal.

- Chain Link Fence (5A): Weave Boundary Wire through the links or use plastic quick ties.
- Wooden Split Rail or Privacy Fence (5A): Use staples to attach Boundary Wire. Avoid puncturing the insulation of the Boundary Wire.

### To Cross Hard Surfaces (sidewalks, pathways etc.)

**Concrete Sidewalk (5B):** Place the Boundary Wire in a convenient expansion joint or create a groove using a circular saw and masonry blade. Place the Boundary Wire in the groove and cover with an appropriate waterproofing compound. For best results, brush away dirt or other debris before patching.

**Gravel or Dirt Pathway (5C):** Place the Boundary Wire in a PVC pipe or water hose to protect the Boundary Wire before burying.

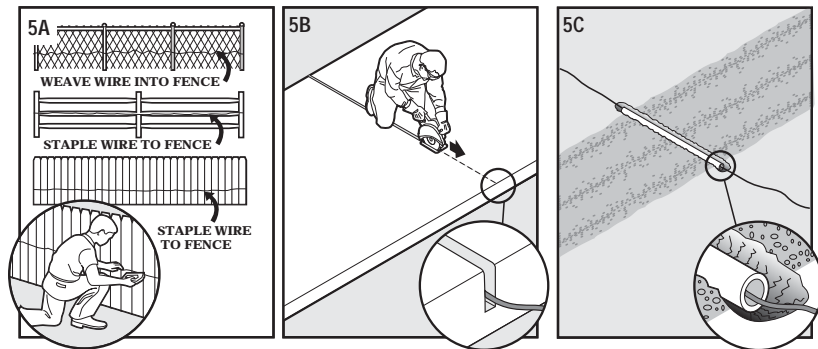

# Training Guide

The PetSafe® Pawz Away™ Outdoor Pet Barrier operates on the principle of positive and negative reinforcement. Your pet will learn to avoid the Barrier Areas you have set after receiving a progressive Static Correction (negative reinforcement) and your pet will learn that he is more comfortable when he avoids the Barrier Areas (positive reinforcement).

In some cases, it may not be necessary to train your pet. You can let your pet wander freely to determine the new boundaries. **Monitor your pet during his first session.** Pets learn at different rates and it may take several times for your pet to successfully understand and honor the Barrier Areas.

## Begin Your Pet's First Session

1. Move your pet away from the Barrier Area.
2. Activate the Receiver Collar by turning the battery door to the ON position. Place the Receiver Collar around your pet's neck. Be sure that the Receiver is directly under your pet's neck.
3. Allow your pet to wander freely to learn the new boundaries.

## Further Training

If your pet is confused or unsure how to avoid the Barrier Areas then you may need to teach your pet how to do so by following these easy training steps:

1. Place a second non metallic collar on your pet ABOVE the Receiver Collar and attach a long leash. *Note: Be sure the extra collar does not put pressure on the Contact Points of the Receiver Collar.*
2. Walk your pet toward the Barrier Area. As soon as you hear the tone or you see that your pet is receiving a Static Correction, gently pull him away from the Barrier Area and back into the safe zone.
3. Reward your pet with praise each time he leaves the Barrier Area.
4. Practice this technique a few times until you feel that your pet is mastering avoidance of the Barrier Areas.

If your pet is having trouble recognizing the barrier you may need to provide a temporary visual aid. PetSafe® Boundary Flags can be placed around the perimeter of the Barrier Area to help your pet understand where he is not allowed to roam. Once your pet is trained to respect the barrier, the flags can be removed. Boundary Flags can be purchased through the Customer Care Center.

**Important: Be sure to never force or entice your pet to enter the Barrier Areas.**

---

## Additional Information

- The system should only be used with healthy pets. Contact your veterinarian if you have concerns about the medical condition of your pet (medication, pregnant, heart conditions, etc).
- This system is not for vicious or aggressive pets. If your pet may pose a threat to others, **DO NOT USE THIS SYSTEM.** If you are unsure if your dog is aggressive, please consult your veterinarian or a certified trainer.

# Troubleshooting

|   |   |
|---|---|
| <b>Barrier Transmitter does not appear to work</b>                              | <ul style="list-style-type: none"><li>• Check segment indicator on Barrier Transmitter.</li><li>• Check/replace batteries in Barrier Transmitter.</li><li>• Increase the Barrier Area range on the Barrier Transmitter.</li></ul>   |
| <b>Barrier Area range is too low</b>  | <ul style="list-style-type: none"><li>• Check/replace batteries in Receiver Collar.</li><li>• Adjust Barrier Transmitter range to increase Barrier Area size.</li></ul>   |
| <b>Barrier Area range is too high</b>   | <ul style="list-style-type: none"><li>• Adjust Barrier Transmitter range to decrease Barrier Area size.</li></ul>   |
| <b>No segments on Barrier Transmitter</b>                                       | <ul style="list-style-type: none"><li>• Press the UP (+) arrow button.</li><li>• Check/replace batteries in Barrier Transmitter.</li></ul>  |
| <b>Black bar(s) appear next to range segment on Barrier Transmitter display</b> | <ul style="list-style-type: none"><li>• Contact the Customer Care Center at for assistance.</li></ul>   |
| <b>Pet receiver stimulation while indoors</b>                                   | <ul style="list-style-type: none"><li>• Remove Receiver Collar before bringing dog indoors.</li><li>• Adjust Barrier Transmitter range to decrease Barrier Area size.</li><li>• Move Barrier Transmitter or Boundary Wire further from house.</li></ul>   |
| <b>Receiver Collar is not picking up signal (wire option only).</b>             | <ul style="list-style-type: none"><li>• Check/replace batteries in Receiver Collar.</li><li>• Use Test Light Tool to check for static correction.</li><li>• Change switch inside transmitter to Internal and check transmitter. If transmitter works and the receiver collar is picking up the signal, then it is likely that there is an issue with the Boundary Wire. Turn off the transmitter. Check the wire connection to the transmitter to ensure connection has not come loose or is corroded. If there is corrosion, cut out the corroded wire and reconnect the wire to the transmitter. If the connection is secure and there is no corrosion then you have a break in the Boundary Wire. To locate the break, check the boundary for any signs of damage (i.e. recent digging, aerating, rodent burrowing or any other noticeable disturbance in your yard next to the Boundary). If there are no signs of damage, you will need to carefully pull up the wire to determine where the break is. Once you have found the break, replace the damaged section of Boundary Wire with new Boundary Wire. Turn the transmitter on and test the system before re-installing the Boundary Wire.</li></ul> |

# Terms of Use and Limitation of Liability

## 1. Terms of Use

This Product is offered to you conditioned upon your acceptance without modification of the terms, conditions and notices contained herein. Usage of this Product implies acceptance of all such terms, conditions, and notices.

## 2. Proper Use

This Product is designed for use with pets where training is desired. The specific temperament of your pet may not work with this Product. We recommend that you not use this Product if your pet is less than 5 pounds or if your pet is aggressive. If you are unsure whether this is appropriate for your pet, please consult your veterinarian or certified trainer.

Proper use includes reviewing the entire Guide provided with your Product and any specific Caution statements.

## 3. No Unlawful or Prohibited Use

This Product is designed for use with pets only. This pet training device is not intended to harm, injure or provoke. Using this Product in a way that is not intended could result in violation of Federal, State or local laws.

## 4. Limitation of Liability

In no event shall Radio Systems® Corporation be liable for any direct, indirect, punitive, incidental, special or consequential damages, or any damages whatsoever arising out of or connected with the use or misuse of this Product. Buyer assumes all risks and liability from the use of this Product.

## 5. Modification of Terms and Conditions

Radio Systems® Corporation reserves the right to change the terms, conditions and notices under which this Product is offered.

---

# Compliance

## FCC/Canada

This Class B digital apparatus complies with Canadian ICES-003. This equipment has been tested and found to comply with the limits for a Class B digital device, pursuant to Part 15 of the FCC Rules. These limits are designed to provide reasonable protection against harmful interference when the equipment is operated in a residential environment. This equipment generates, uses, and can radiate radio frequency energy and, if not installed and used in accordance with the instruction guide, may cause harmful interference to radio communications. However, there is no guarantee that interference will not occur in a practical installation. If this equipment causes harmful interference to radio or television reception, which can be determined by turning the equipment off and on, the user is encouraged to try to correct the interference by one or more of the following measures:

- Relocate the interfered receiving antenna.
- Increase the separation between the equipment and receiver.
- Connect the equipment into an outlet on a circuit different to that to which the receiver is connected.
- Contact the Customer Care Center at 1-800-732-2677.

This device complies with Industry Canada Rules. This device complies with part 15 of the FCC Rules. Operation is subject to the following two conditions: (1) This device may not cause harmful interference, and (2) this device must accept any interference received, including interference that may cause undesired operation.

Unauthorized changes or modifications to the equipment, not approved by Radio Systems® Corporation, could result in not meeting compliance with FCC regulations and could void the user's authority to operate the equipment.

## **Australia**

This device complies with the applicable EMC requirements specified by the ACMA (Australian Communications and Media Authority).

## **Customer Care International**

United States / Canada: 1-800-732-2677

Australia: 1800 786 608

New Zealand: 0800 543 054

## **Caution**

This System is NOT a solid barrier. The system is designed to act as a deterrent, using Static Correction to condition pets to remain outside of the established barrier area. It is important that you reinforce training with your pet on a regular basis. Since the tolerance level to Static Correction varies from pet to pet, Radio Systems® Corporation CANNOT guarantee that the system will in all cases keep a pet outside of the established barrier area. Not all pets can be trained to avoid entering the barrier area. Therefore, if you have reason to believe that your pet may harm himself or pose a danger to others if he is not kept from entering the barrier area, you should NOT rely solely upon this system to restrict your pet. Radio Systems® Corporation shall NOT be liable for any personal injuries, property damage, injury to or death of your pet, economic loss or any consequential damages sustained as a result of any animal entering the barrier area.





Radio Systems® Corporation  
10427 Electric Avenue  
Knoxville, TN 37932  
1-800-732-2677  
[www.petsafe.net](http://www.petsafe.net)  
400-1099/1

Covered by US Patents 7,046,152; 7,068,174;  
7,117,822; 7,204,204; 7,278,376; 7,495,570.  
Other patents pending.

© 2008 Radio Systems® Corporation