

### Installation Support • Soporte de instalación • Support d'installation

#### Personal Assistance, Product Specs, & "How-to" Questions:

Asistencia personal, especificaciones del producto y preguntas sobre "cómo hacerlo":

Aide personnelle, spécifications du produit et questions « pratique-pratiques » :

**1-800-PFAUCET (732-8238)**  
**pfisterfaucets.com/support**

Installation Videos Available  
Videos de instalación a disposición  
Vidéos d'installation disponibles



pfisterfaucets.com/videos

#### ▲ WARNING / AVERTENCIA / AVERTISSEMENT

To reduce the risk of injury or property damage, read all instructions before installing product. Wear safety goggles. Product must be installed in accordance with all state & local plumbing & building codes. Call a professional if you are uncertain about installing this product.

Para disminuir el riesgo de lesiones o daños a la propiedad, lea todas las instrucciones antes de instalar el producto. Utilice gafas de seguridad. El producto deberá instalarse de acuerdo con la normativa de plomería y construcción estatal y local. Llame a un profesional si no está seguro sobre cómo instalar este producto.

Pour réduire le risque de blessures ou de dommages, lisez toutes les instructions avant d'installer l'appareil. Porter des lunettes de sécurité. Il faut installer l'appareil en respectant tous les codes de construction et de plomberie locaux et d'État. Appelez un professionnel si vous n'êtes pas certain de la façon d'installer cet appareil.

#### Required Tools Herramientas necesarias Outils nécessaires

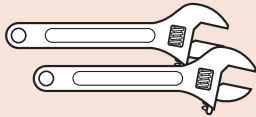

Adjustable Wrenches  
Llaves ajustables  
Clés à mollette



Safety Goggles  
Anteojos de seguridad  
Lunettes de sûreté

#### Additional Helpful Tools Otras herramientas útiles Outils supplémentaires utiles

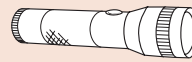

Flashlight  
Linterna  
Lampe-torche



Cloth  
Paño de limpieza  
Chiffon

#### Parts in the Box • Piezas en la caja • Pièces dans la boîte

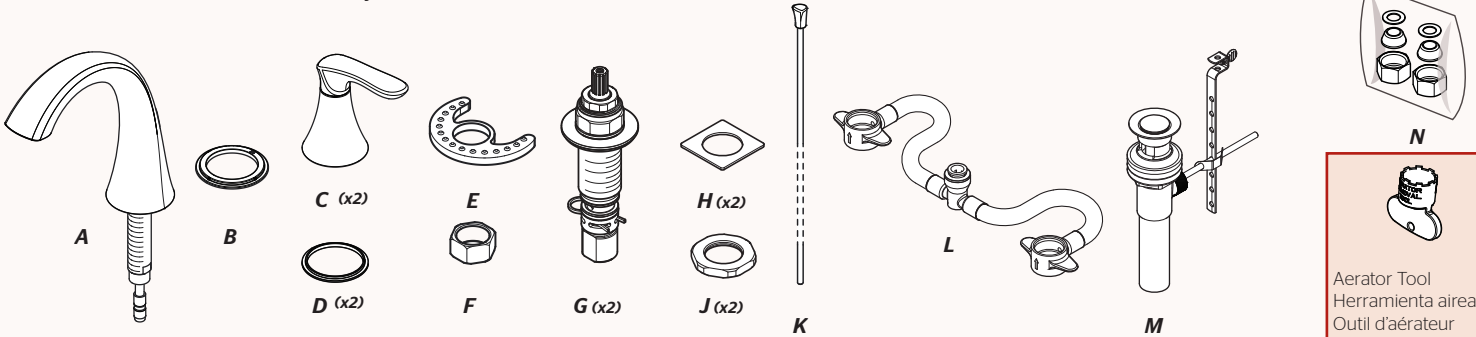

Aerator Tool  
Herramienta aireador  
Outil d'aérateur

## 1 Turn Off Water Supply • Cierre el suministro de agua • Couper l'alimentation en eau



Locate water supply inlets and shut off the water supply valves. These are usually found under the sink or near the water meter. If you are replacing an existing faucet, remove the old faucet from the sink and clean the sink surface thoroughly.

Ubique las entradas del suministro de agua y cierre las válvulas de suministro de agua. Generalmente se encuentran debajo del fregadero o cerca del medidor de agua. Si se trata de un reemplazo de grifo, quite el grifo viejo y limpie completamente la superficie del fregadero.

Repérer les arrivées d'eau et fermer leurs robinets. Ces robinets se trouvent généralement sous le lavabo ou à côté du compteur d'eau. En cas de remplacement d'un robinet existant, le déposer du lavabo et nettoyer soigneusement la surface de ce dernier.

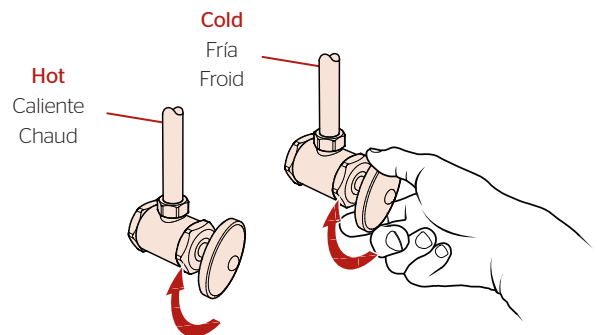

## 2 Prepare & Install Valve Bodies

Prepare e instale los cuerpos de la válvula

Préparez et installez les vannes



Adjustable Wrench  
Llave ajustable  
Clé réglable

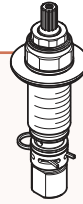

H (x2)



J (x2)

G (x2)

### 2A

#### Disassemble Valves

Desensamble las válvulas

Démontez les vannes

x2

Hot & Cold  
Caliente y fría  
Chaud et froid

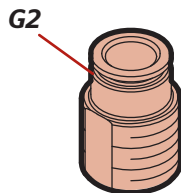
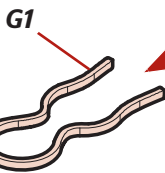
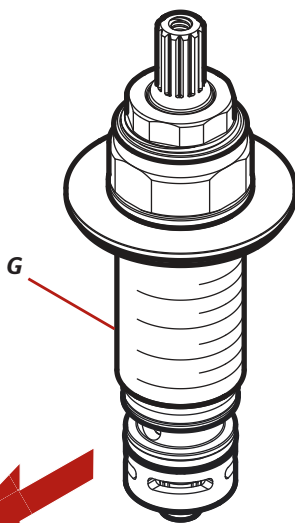

#### Save for step 5.

Guarde para el paso 5.

Mettez de l'étape 5.

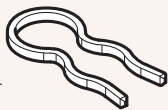

G1 (x2)



G2 (x2)

### 2B

Temporarily place handles onto stems to align the levers. **DO NOT** use handles to tighten valve.

Coloque temporalmente las manijas en los vástagos para alinear las palancas. **NO** utilice las manijas para apretar la válvula.

Placer temporairement les poignées sur les tiges pour aligner les leviers. **NE PAS** utiliser les poignées pour serrer la valve.

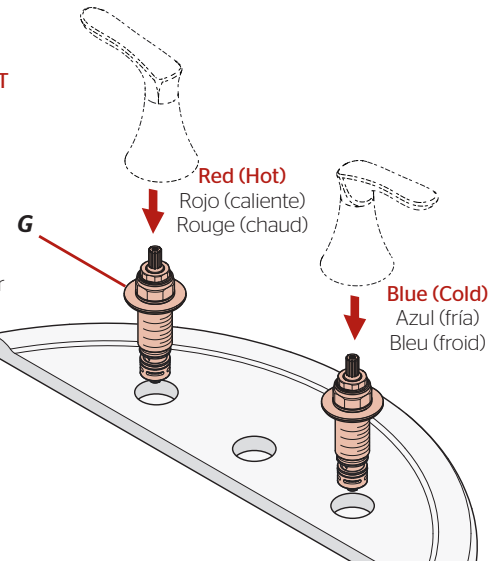

### 2C

**HOT**  
CALIENTE  
CHAUD

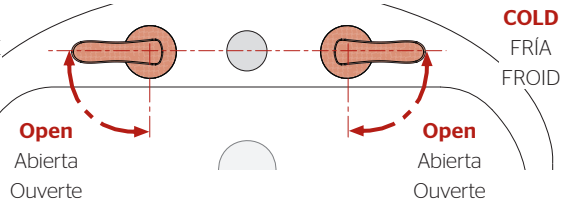

**COLD**  
FRÍA  
FROID

**Before final tightening, be sure that both handles rotate as shown.**

Antes del apriete final, asegúrese de que ambas manijas giran como se muestra.  
Avant le serrage final, être sûr que les deux poignées tournent comme indiqué.

### 2D

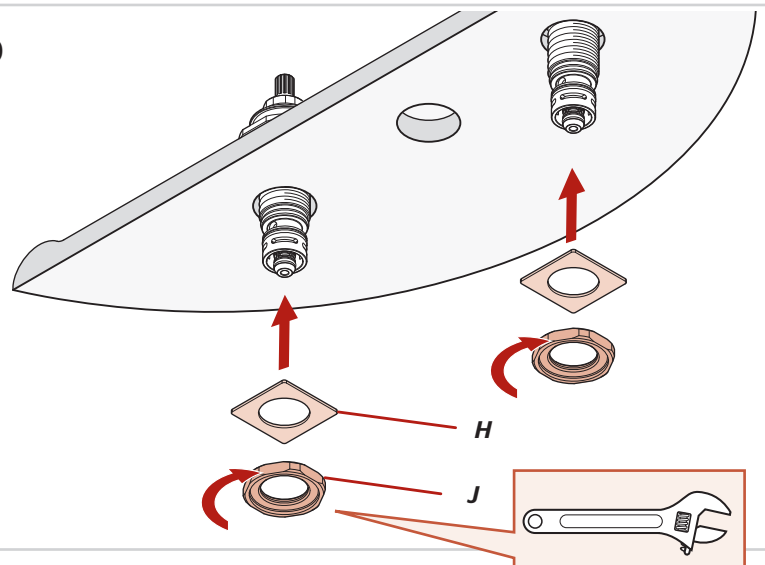

### 3

## Install Handles & Spout

Instale las manijas y el surtidor

Installez les poignées et le bec

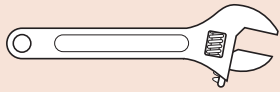

Adjustable Wrench  
Llave ajustable  
Clé réglable

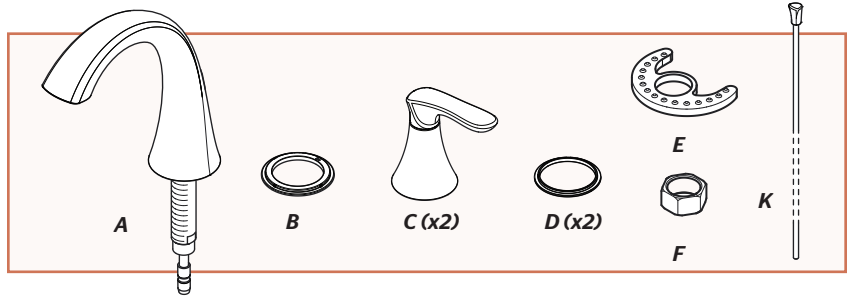

### 3A

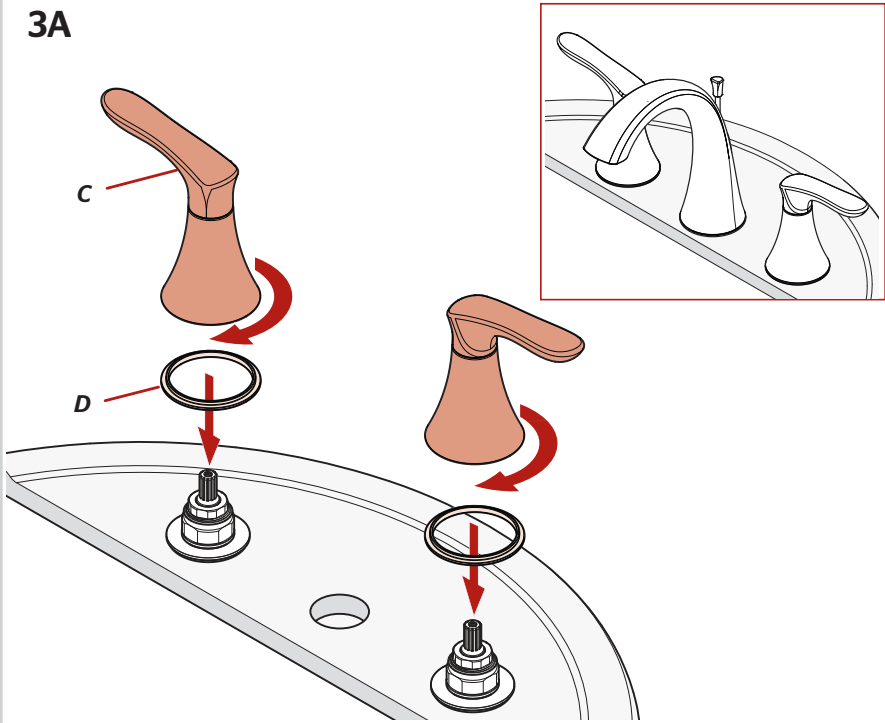

### 3B

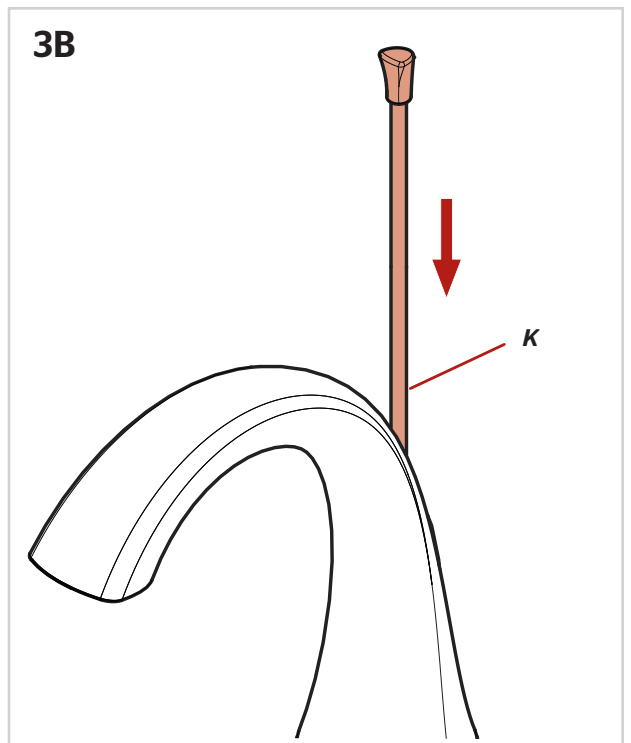

### 3C

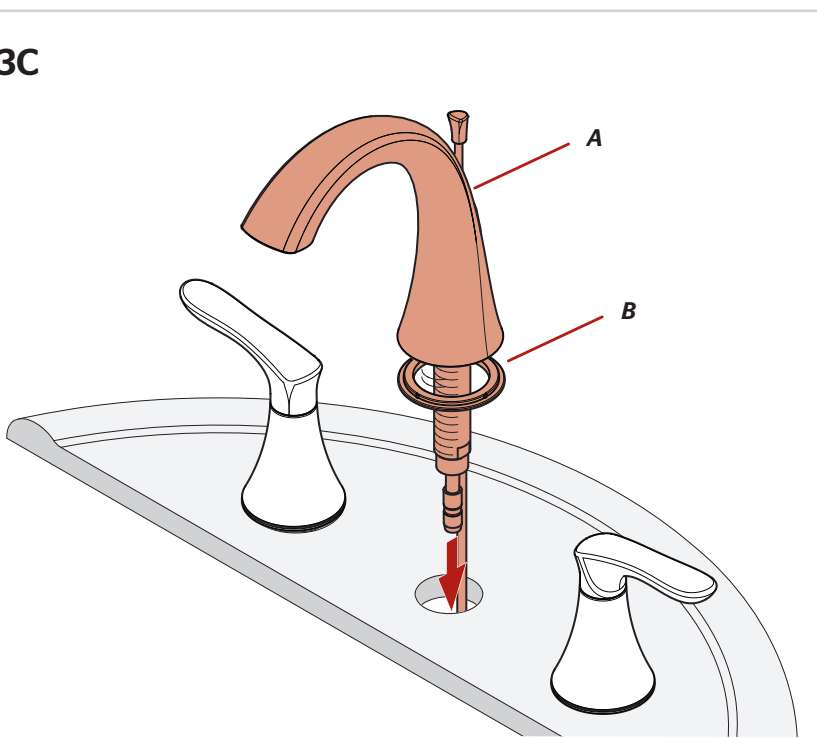

### 3D

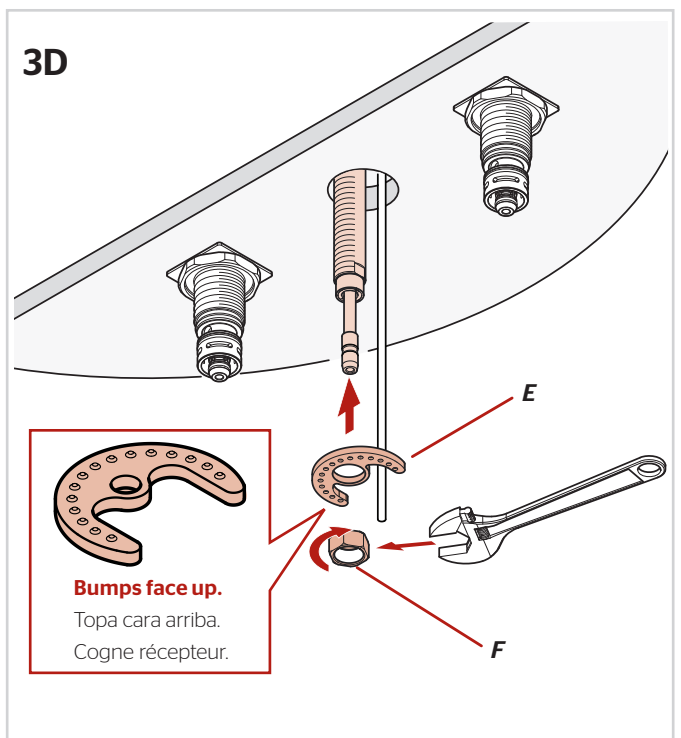

# 4

## Install Hose

Instale la manguera

Posez le tuyau

No Tools Required for This Step  
No se necesitan herramientas para este paso  
Aucun outil n'est nécessaire pour cette étape

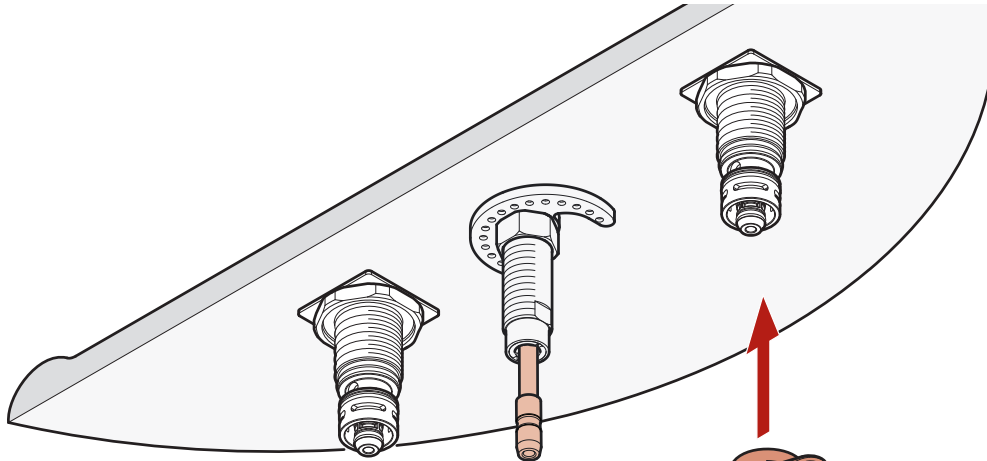
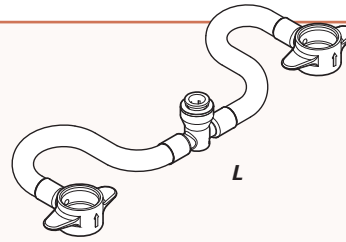

**IMPORTANT: DO NOT damage O-Rings.**  
**IMPORTANTE: NO dañe las juntas tóricas.**  
**IMPORTANT: NE PAS endommager les joints toriques.**

### Remove protective cap

Retire la cubierta protectora.  
Enlevez le capuchon protecteur.

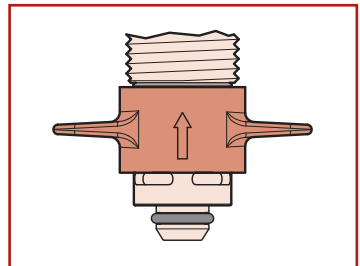
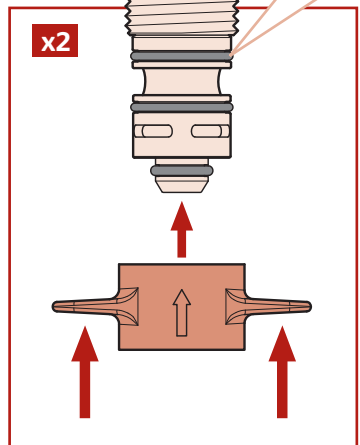
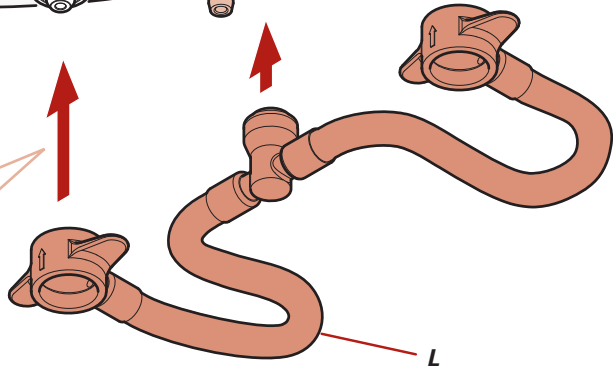

**Check to see if the connection is secure by pulling down the Center Connector. If the Inner Collet separates slightly but does not pull off the Receiving Tube, connection is secure.**

Revise si la conexión es segura halando hacia abajo el Quick Connector™. Si la anilla interna se separa ligeramente pero no se desprende del tubo receptor, la conexión está segura.

Vérifiez que le raccord est bien serré en tirant sur le Quick Connector™. Si le collet interne se sépare légèrement mais ne se détache pas du tube de réception, le raccord est bien serré.

Center Connector  
Centre el conector  
Raccord centre

Inner Colet  
Anilla interna  
Collette interne

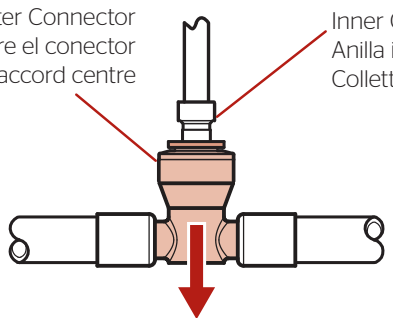

# 5

## Connect Water Supply Lines

Conecte las tuberías de suministro de agua

Raccorder les conduites d'alimentation en eau

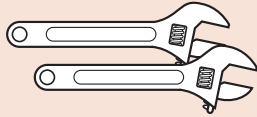

Adjustable Wrenches  
Llaves ajustables  
Clés à mollette



G1 (x2)



G2 (x2)

**From Step 2.**

Desde el paso 2.

De l'étape 2.



**Water Supply Lines not included. Please consult manufacturer and/or its instructions for the correct method of installation of supply lines & fittings.**

**IMPORTANT: Incorrect application of supply lines and fittings may result in the failure or leak of the supply lines and fitting.**

**Las tuberías de suministro de agua no están incluidas.** Consulte por favor el fabricante y/o sus instrucciones para el método correcto de instalación de líneas de suministro y de guarniciones.

**IMPORTANTE:** El uso incorrecto de líneas de suministro y de guarniciones puede dar lugar a la falta o al escape de las líneas de suministro y de la guarnición.

**Les tuyaux d'arrivée d'eau ne sont pas fournis.** Veuillez consulter le fabricant et/ou ses instructions pour la méthode correcte d'installation des canalisations et des garnitures d'alimentation.

**IMPORTANT:** L'application incorrecte des canalisations et des garnitures d'alimentation peut avoir comme conséquence l'échec ou la fuite des canalisations et de l'ajustage de précision d'alimentation.

5A

x2

Hot & Cold  
Caliente y fría  
Chaud et froid

G2

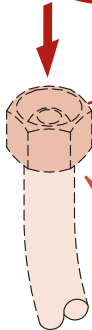
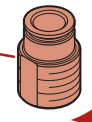

Water supply line  
línea de suministro del agua  
ligne d'approvisionnement en eau

G2

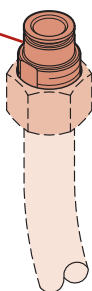

5B

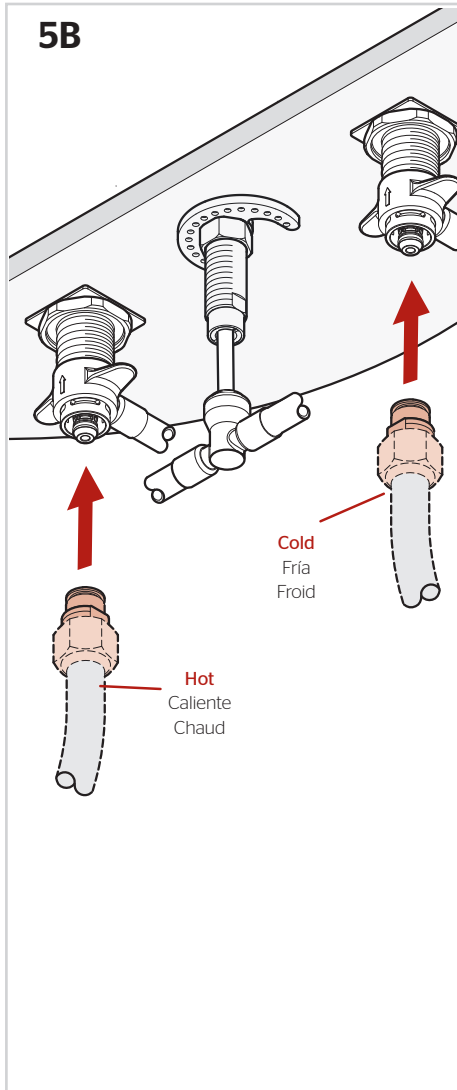

Cold  
Fría  
Froid

Hot  
Caliente  
Chaud

5C

x2

Hot & Cold  
Caliente y fría  
Chaud et froid

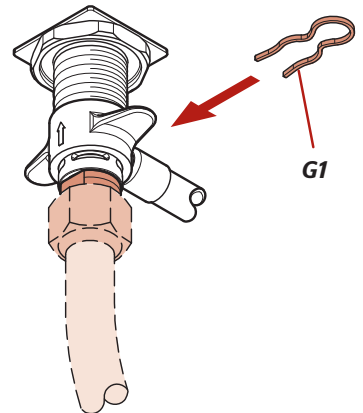

G1

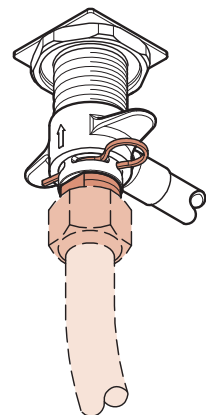

# 6

## Prepare & Install Pop-Up

Prepare e instale el tapón retráctil

Préparez & installez le bouchon à clapet

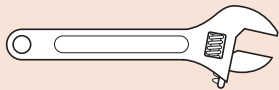

Adjustable Wrench  
Llave ajustable  
Clé réglable

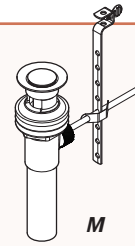

### 6A

#### Disassemble Pop-up Assembly

Desensamble el ensamble del tapón retráctil

Démontez l'ensemble bouchon à clapet

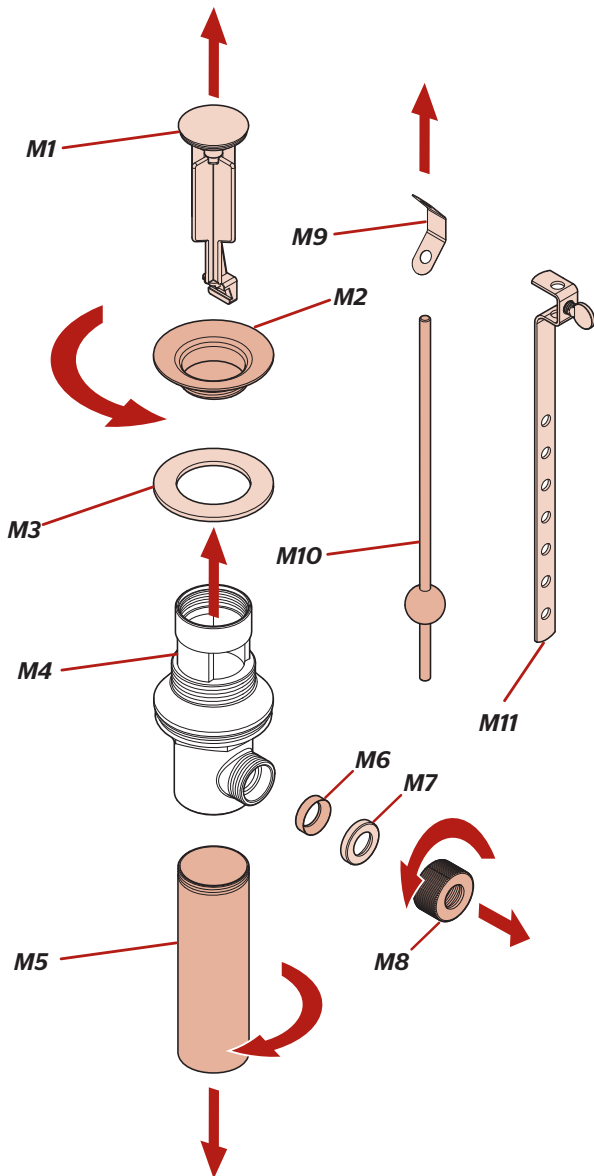

### 6B

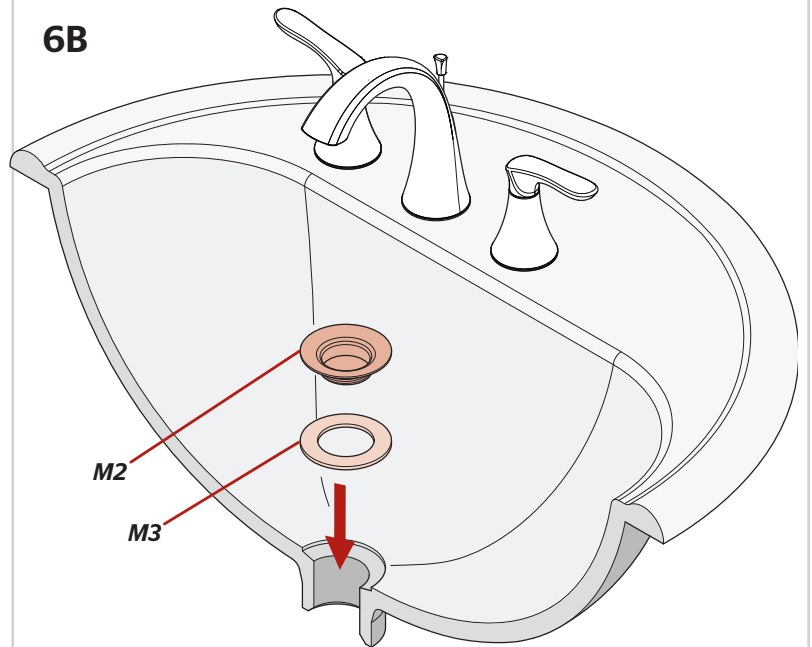

### 6C

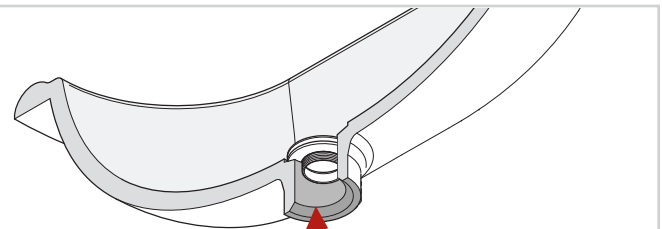

**Thread Drain Body (M4) to bottom of Flange (M2) and adjust so that Ball Rod opening faces rear.**

Enrosque la estructura de desagüe (M4) a la parte inferior de la pestaña (M2) y ajuste de modo que la abertura de la varilla con glóbulo esté orientada hacia la parte posterior.

Vissez le corps du renvoi (M4) au bas de la bride (M2) et réglez de façon à ce que l'ouverture de la tige soit tournée vers l'arrière.

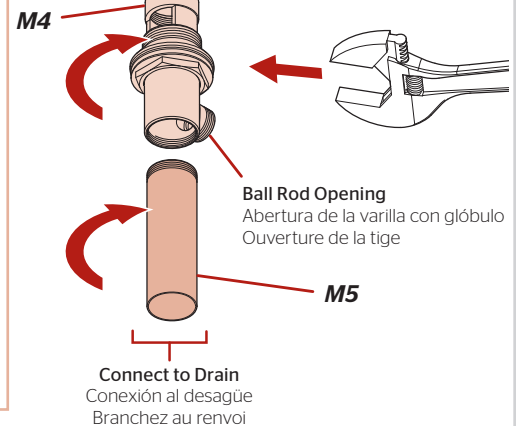

## 7 Prepare & Connect Lift Rod

Prepare y conecte la varilla de elevación

Préparez & connectez la tige levier

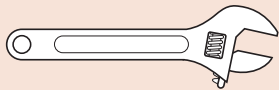

Adjustable Wrench  
Llave ajustable  
Clé réglable

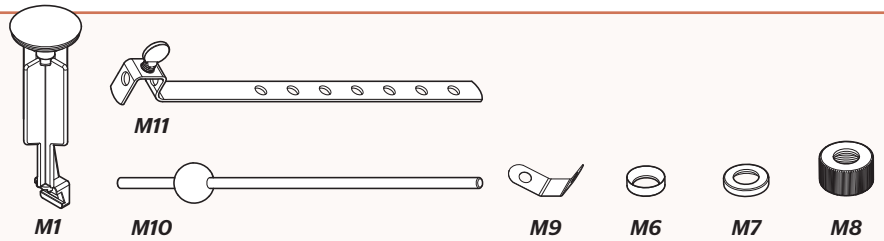

### 7A

**Option 1**  
Opción 1  
Option 1

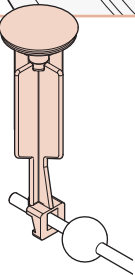

**Option 2**  
Opción 2  
Option 2

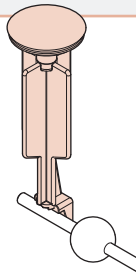

**M1 can be installed in two ways: Fixed Position (Option 1) or a Removable Position (Option 2)**

M1 puede instalarse de dos formas: posición fija (Opción 1) o posición removable (Opción 2).

On peut installer M1 de deux façons : Position fixe (Option 1) ou position amovible (Option 2).

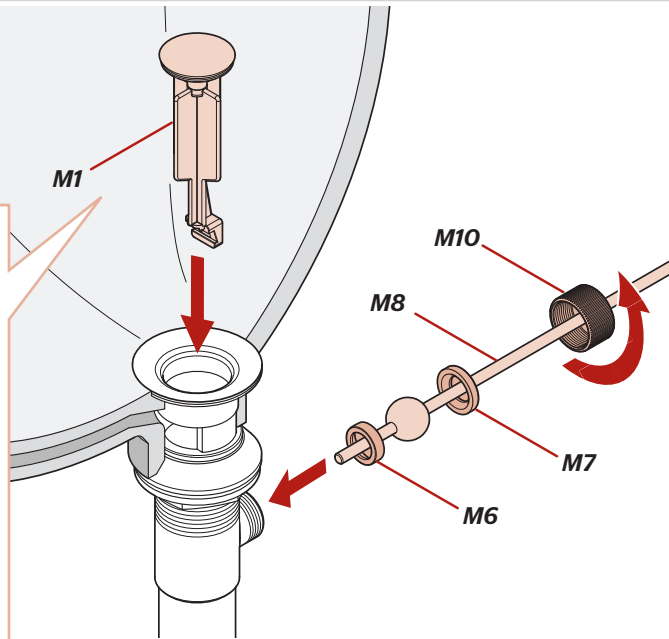

### 7B Assemble Lift Rod Connection

Ensamble de la conexión de varilla de elevación

Assemblez la connexion de la tige levier

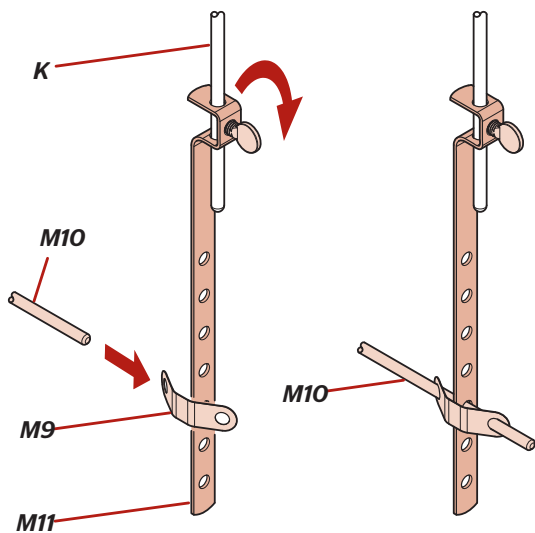

### 7C Pop-Up Completion

Terminer le bouchon à clapet

Finalización de la instalación del tapón retráctil

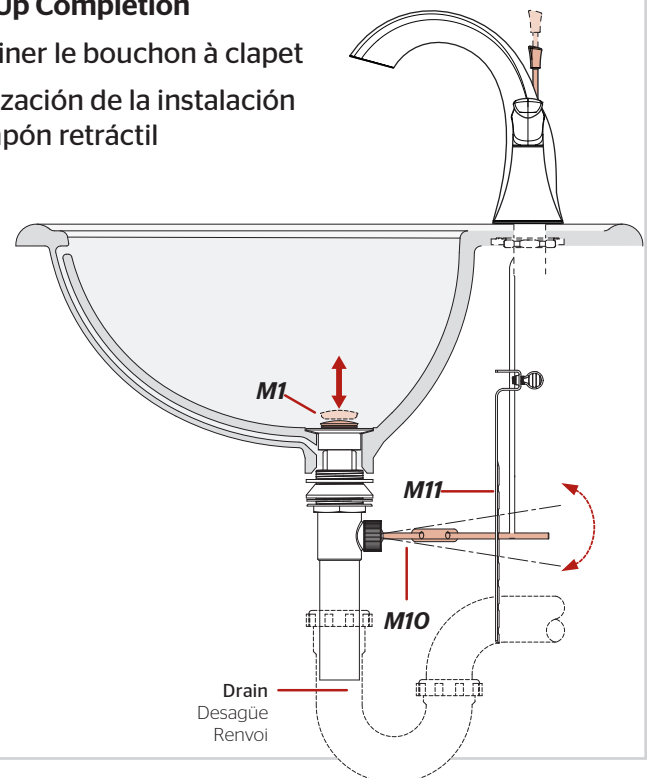

## 8 Turn On Water & Confirm Proper Installation

Active el suministro de agua y confirme que la instalación está adecuadamente efectuada

Ouvrez l'eau et confirmez que l'installation est adéquate

### 8A

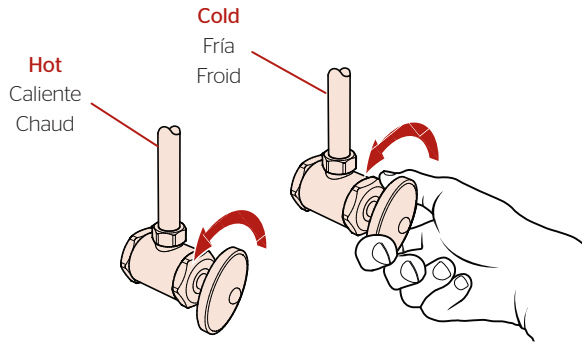

### Faucet Functions • Funciones del grifo • Fonctions du robinet

Hot  
Caliente  
Chaud

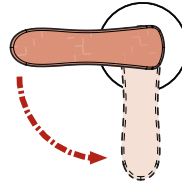

Open  
Abierta  
Ouvverte

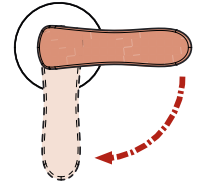
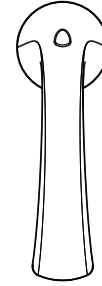

Cold  
Fría  
Froid

Open  
Abierta  
Ouvverte



**Check for leaks above and below the sink.**

Revise si hay fugas encima y debajo del fregadero

Assurez-vous qu'il n'y a pas de fuite au dessus ou au dessous du lavabo

## 9 Flush the Faucet

Enjuague el grifo

Vidanger l'robinet

### 9A Remove Aerator Retire el aereador Retirez l'aérateur

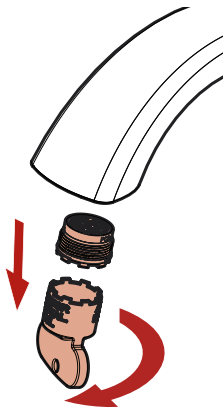

### 9B

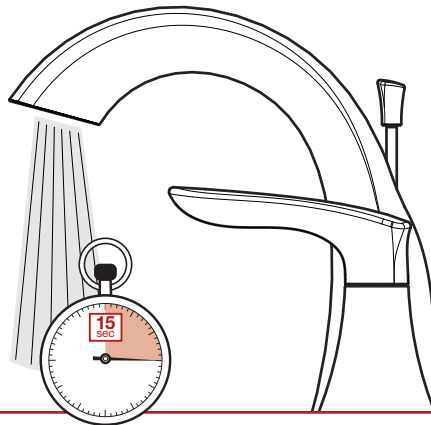

**Allow full hot & full cold water to run for at least 15 seconds each.**

Deje correr el agua caliente y fría durante al menos 15 segundos cada una.

Permettez à l'eau chaude et l'eau froide de couler au moins 15 secondes chacun.

### 9C Reinstall Aerator Reinstale el aereador Réinstallez l'aérateur

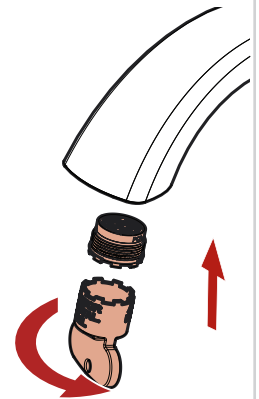

**Hand Tighten**

Apriete con la mano

Serrez manuellement

**For Additional Installation Help:**

Para la instalación adicionales de ayuda:

Pour aider à l'installation supplémentaires:

**Pfister**

**1-800-PFAUCET (732-8238)**  
**pfisterfaucets.com**