

LG40-MF1C Finish(C)

LG40-MF1K Finish(K)

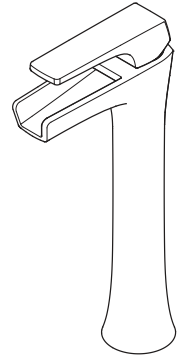

Specifications

- All Metal Construction
- Pforever Seal

Features

- 1.2 GPM Flow Rate
- All Metal Construction
- Trough Spout
- Pforever Seal Ceramic Disc Valves
- Pforever Warranty®

Code Compliance

Pfister products are designed and manufactured in compliance with the following standards and codes:

- IAPMO Certified
- CSA B125 Certified
- ASME A112.18.1
- Cal Green Compliant
- NSF 61/9 Annex G (Low lead)
- EPA WaterSense Certification 1.5 gpm, 5.7 L/Min
- ADA Compliant-ANSI A117.1 (Lever handles only)



Dimensions

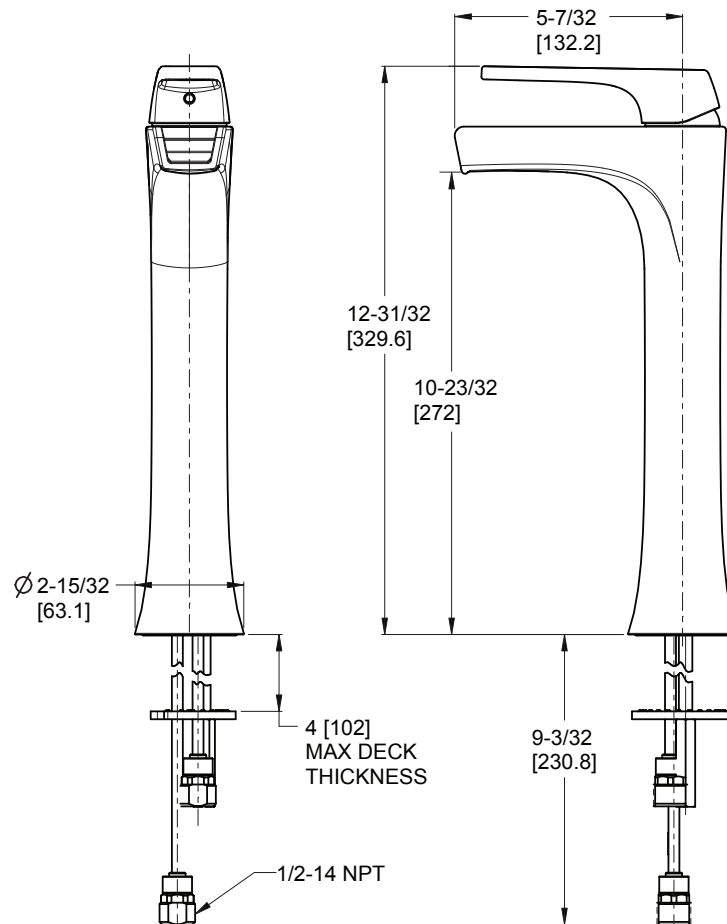

Ø1 Min to Ø1-1/2 Max. Deck Hole Openings